

HOT SPOT[®]

A photograph of a man and a woman relaxing in a hot tub at night. The woman, on the left, has blonde hair and is wearing a blue top. The man, on the right, has dark hair and is wearing a dark shirt. They are both smiling and looking towards the camera. The hot tub is illuminated, and the background shows dark foliage with some lights.

Owner's Manual
50 Hz

HOT SPOT



Watkins Manufacturing Corporation congratulates you on your decision to enjoy the finest spa available... Welcome to the growing family of Hot Spot® Spa owners.

Owner's Manual

This Owner's Manual will acquaint you with your new spa's operation and general maintenance. We suggest that you take some time to carefully review all nine sections. Please keep this manual available for reference.

If you have any questions about any aspect of your spa's set-up, operation or maintenance, contact your authorized Hot Spot Spa dealer. They are trained professionals who are familiar with the product as well as new spa ownership concerns. Their expertise will facilitate the enjoyment of your new Hot Spot Spa.

The Serial Number/Identification label is located within the equipment compartment of your Hot Spot Spa. The serial number should also be documented on the delivery receipt from your dealer.

IMPORTANT: Watkins Manufacturing Corporation reserves the right to change specifications, colors, surface materials or design without notification and without incurring any obligation.

DATE PURCHASED: _____

DATE INSTALLED: _____

DEALER: _____

ADDRESS: _____

TELEPHONE: _____

SPA MODEL/SERIAL NUMBER: _____

COVER SERIAL NUMBER: _____

In most cities and counties, permits will be required for the installation of electrical circuits or the construction of exterior surfaces (decks and gazebos). In addition, some communities have adopted residential barrier codes which may require fencing and/or self-closing gates on the property to prevent unsupervised access to a pool (or spa) by children under 5 years of age. Your Hot Spot Spa is equipped with a locking cover that meets the ASTM F1346-91 Standard for Safety Covers and as a result, is usually exempt from most barrier requirements. As a general practice, your local Building Department will inform you of any applicable barrier requirements at the time a permit is obtained for the installation of an electrical circuit. Your Hot Spot spa dealer can provide information on which permits may be required.

TABLE OF CONTENTS

1. SAFETY INFORMATION

Important Safety Instructions	1
Important Spa Instructions	3

2. INSTALLATION INSTRUCTIONS

Site Preparation	3
Outdoor Installation and Patio Installation	4
Deck Installation	4
Indoor/Basement Installation	4
Spa Leveling Instructions	4
Spa Cover Installation	5

3. ELECTRICAL INSTALLATION

Electrical Requirements and Precautions	7
240 Volt Subpanel Wiring (Sprint™ & Dash™)	7
240 Volt Subpanel Wiring (Tempo™, Relay™, Stride™, SX & TX Models)	8

4. SPA SPECIFICATIONS & ILLUSTRATION

Tempo (Model TEME)	9
Relay (Model RELE)	10
Stride (Model STDE)	11
SX (Model SXE)	12
TX (Model TXE)	13
Sprint (Model SPRE)	14
Dash (Model DASE)	15

5. OPERATING INSTRUCTIONS

Start-up and Refill Procedures	16
Heating and Hydromassage Systems	17
Safety Equipment	18
Spa Control Panel (Tempo, Relay, Stride, SX & TX Models)	18
Locking Features	20
Spa Control Panel (Sprint & Dash Models)	20

6. JET MENUS

Tempo (Model TEME)	22
Relay (Model RELE)	23
Stride (Model STDE)	24
SX (Model SXE)	25

TX (Model TXE)	26
Sprint (Model SPRE)	27
Dash (Model DASE)	28

7. WATER QUALITY AND MAINTENANCE

General Information	29
Methods for Testing the Spa Water	29
Hot Spot® Spa Water Maintenance Program	30
Freshwater Ag+® Silver Ion System	32
EverFresh® Water Care System	32
Hot Spot Water Treatment Guide	33
Ozone (Optional)	35
Common Water Chemistry Questions	36
Water Terminology	37

8. MAINTENANCE AND SPA CARE

Filter Maintenance	38
Care of Spa Pillow	39
Care of the Exterior	39
Care of the Spa Cover	39
Care of the Spa Cabinet	40
Draining your Spa	40
Non-Operation in Cold Climate	40
Winterizing your Spa	40

9. SERVICE INFORMATION

General Information	41
GFCI and High Limit Thermostat	41
Miscellaneous Service Information	41
Acts Invalidating Warranty	42
Disclaimers	42
Watkins Customer Service	42
Troubleshooting (Tempo, Relay, Stride, SX & TX Models)	43
Troubleshooting (Sprint & Dash Models)	44
Priming the Pumps	45

SAFETY INFORMATION

IMPORTANT SAFETY INSTRUCTIONS

(Read and follow all instructions)

AVOIDING THE RISK TO CHILDREN

WARNING:

- RISK OF CHILD DROWNING. Extreme caution must be exercised to prevent unauthorized access by children. To avoid accidents, ensure that children cannot use a spa unless they are supervised at all times.
- To reduce the risk of injury, do not permit children to use this product unless they are closely supervised at all times.
- To reduce the risk of injury, lower water temperatures are recommended for young children. Children are especially sensitive to hot water.

DO:

- Make sure you always lock the child resistant locks after using the spa for your children's safety. Every Hot Spot® is equipped with a locking cover that meets the ASTM F1346-91 Standard for Safety Covers.
- Test the water temperature with your hand before allowing your child to enter the spa to be sure that it's comfortable. Children are especially sensitive to hot water.
- Remind children that wet surfaces can be very slippery. Make sure that the children are careful when entering or exiting the spa.

DON'T:

- Allow children to climb onto the spa cover.
- Allow children to have unsupervised access to the spa.

AVOIDING THE RISK OF ELECTROCUTION

RISK OF ELECTROCUTION

- Connect only to a grounded source. The spa must be connected to a Ground Fault Circuit Interrupter (GFCI). Watkins Manufacturing Corporation does not supply a GFCI with the spa. Watkins recommends the GFCI be attached to the end of the spa's electrical cord. Additionally, the GFCI should be VDE listed and approved by a licensed electrician complying to all local codes using 16 amps with a maximum 10 milliamp trip. Contact your authorized spa dealer.

WARNING:

Always test the Ground Fault Circuit Interrupter (GFCI) before each use of the spa. If the GFCI does not perform properly, a ground current is flowing indicating the possibility of electric shock. Disconnect power to the spa until the fault has been identified and corrected.

- Do not bury the power cord. A buried power cord may result in death or serious personal injury due to electrocution if direct burial-type cable is not used, or if improper digging occurs.

WARNING:

To reduce the risk of electrical shock, replace a damaged cord immediately. Failure to do so may result in death or serious personal injury due to electrocution.

- A ground terminal (pressure wire connector) is provided on the control box inside the unit to permit connection of a minimum No. 8.4 mm² (8 AWG) solid copper bonding conductor between this point and any metal equipment, metal water pipe, metal enclosures of electrical equipment, or conduit within 1.5 m (five feet) of the unit as needed to comply with local requirements. If the spa is located on a reinforced concrete pad, the reinforced steel should also be bonded to the ground terminal.

DANGER: RISK OF ELECTRICAL SHOCK

- Install at least 1.5 m (five feet) from all metal surfaces. A spa may be installed within 1.5 m (five feet) of a metal surface if each metal surface is permanently connected by a minimum No. 6 mm² (10 AWG) solid copper conductor attached to the wire ground connector on the terminal box that is provided for this purpose.
- Do not permit any electrical appliances, such as a light, telephone, radio, or television within 1.5 m (five feet) of a spa. Failure to maintain a safe distance may result in death, or serious personal injury due to electrocution, if the appliance should fall into the spa.

DO:

- Be sure your spa is connected to the power supply correctly - use a licensed contractor.
- Disconnect the spa from the power supply before draining the spa or servicing the electrical components.
- Test the Ground Fault Circuit Interrupter(s) before each use.

DON'T:

- Use the spa with the equipment compartment door removed.
- Place electrical appliances within 1.5 m (five feet) of the spa.
- Use an extension cord to connect the spa to its power source. The cord may not be properly grounded and the connection is a shock hazard. An extension cord may cause a voltage drop, which will cause overheating of the jet pump motor and motor damage.
- Attempt to open the electrical control box. There are no user serviceable parts inside.

RISKS TO AVOID

⚠ DANGER: RISK OF INJURY

- DO NOT sit in the filter compartment area. Sitting in this area can cause:
a) Restriction of Filter Pump suction/vacuum b) Damage to components
Both can result in bodily harm. Should damage occur to components in this area, replace immediately!
- To reduce the risk of injury to persons, DO NOT remove suction fittings (filter standpipes) located in the filter compartment.
- The suction fittings in the spa are sized to match the specific water flow created by the pump. Should the need arise to replace the suction fittings, or the pump, be sure that the flow rates are compatible.
- There is a danger of slipping and falling. Remember that wet surfaces can be very slippery. Take care when entering or exiting the spa.
- People with infectious diseases should not use the spa.
- Keep any loose articles of clothing, long hair or hanging jewelry away from rotating jets or other moving components.

INCREASED SIDE EFFECTS OF MEDICATION

- The use of drugs, alcohol, or medication before or during spa use may lead to unconsciousness with the possibility of drowning.
- Persons using medications should consult a physician before using a spa; some medication may cause a user to become drowsy, while other medication may affect heart rate, blood pressure, and circulation.
- Persons taking medications that induce drowsiness, such as tranquilizers, antihistamines, or anticoagulants should not use the spa.

HEALTH PROBLEMS AFFECTED BY SPA USE

- Pregnant women should consult a physician before using spa.
- Persons suffering from obesity or with a medical history of heart disease, low or high blood pressure, circulatory system problems, or diabetes should consult a physician before using spa.

UNCLEAN WATER

- Keep the water clean and sanitized with correct chemical care. The recommended levels for your Hot Spot® spa are:

Free Available Chlorine (FAC):	3.0-5.0 ppm	Total Alkalinity:	40-120 ppm
Water pH:	7.2-7.6	Calcium Hardness:	50-150 ppm

(Refer to Water Quality and Maintenance section for complete instructions.)

Important: Turn on the jet pump for a least ten minutes after adding ANY spa water chemicals into the filter compartment.

- Clean the filter cartridge monthly to remove debris and mineral buildup which may affect the performance of the hydromassage jets, limit the flow, or trip the high limit thermostat which will turn off the entire spa.

AVOIDING THE RISK OF HYPERTHERMIA

Prolonged immersion in hot water can result in HYPERTHERMIA, a dangerous condition which occurs when the internal temperature of the body reaches a level above normal (37°C or 98.6°F). The symptoms of hyperthermia include unawareness of impending hazard, failure to perceive heat, failure to recognize the need to exit the spa, physical inability to exit the spa, fetal damage in pregnant women, and unconsciousness resulting in a danger of drowning.

⚠ WARNING:

The use of alcohol, drugs, or medication can greatly increase the risk of fatal hyperthermia in hot tubs and spas.

TO REDUCE THE RISK OF INJURY:

- The water in the spa should never exceed 104°F (40°C). Water temperatures between 100°F (38°C) and 104°F (40°C) are considered safe for a healthy adult. Extended use can cause hyperthermia. Lower water temperatures are recommended for extended use (exceeding ten minutes) and for young children.
- Pregnant or possibly pregnant women should limit spa water temperatures to 100°F (38°C). Failure to do so may result in permanent injury to your baby.
- Do not use spa immediately following strenuous exercise.

AVOIDING THE RISK OF SKIN BURNS:

WARNING:

- To reduce the risk of injury, before entering a spa the user should measure the water temperature since the tolerance of temperature-regulating devices may vary.
- Test the water with your hand before entering the spa to be sure it's comfortable.

SAFETY SIGN

Each Hot Spot® spa is shipped with a SAFETY SIGN in the owner's package. The sign, which is required as a condition of Product Listing, should be permanently installed where it is visible to the users of the spa. To obtain additional SAFETY SIGNS, contact your Hot Spot dealer and request Part #003021.

IMPORTANT SPA INSTRUCTIONS

The following contains important spa information, and we strongly encourage you to read and apply them.

DO:

- Use and lock the cover when the spa is not in use, whether it is empty or full.
- Follow the Spa Care and Maintenance recommendations stated in this manual.
- Use only approved accessories and recommended spa chemicals and cleaners.

DON'T:

- Leave the Hot Spot spa exposed to the sun without water or the cover in place. Exposure to direct sunlight can cause solar distress of the shell material.
- Roll or slide the spa on its side. This will damage the siding.
- Lift or drag the vinyl cover by using the cover lock straps; always lift or carry the cover by using the handles.
- Attempt to open the electrical control box. There are no user serviceable parts inside. Opening of the control box by the spa owner will void the warranty. If you have an operational problem, carefully go through the steps outlined in the Troubleshooting section. If you are not able to resolve the problem, contact your authorized Hot Spot spa dealer. Many problems can easily be diagnosed over the telephone by an authorized service technician.

INSTALLATION INSTRUCTIONS

SITE PREPARATION

You probably have a spot picked out for your new spa, whether it's indoors or outdoors, on a patio or on a deck. Just make sure you check the following:

- Always put your spa on a structurally sound, level surface. A filled spa can weigh a great deal. Make certain that the location you choose can support the weight of your filled spa.
- Don't forget to level your spa before filling it (see Spa Leveling Preparation on next page).
- Locate your equipment compartment, which houses all of the electrical components, in a place where water will drain away from it. Allowing water into the equipment compartment can damage the electronics, or may result in tripping your home's circuit breaker.
- Leave yourself easy access to the Ground Fault Circuit Interrupter (GFCI) for testing. The GFCI is located at the end of the power cord, or at the subpanel of a hard-wired spa.
- Never let water get into the subpanel or into the electrical outlet that your spa is plugged into. Consult your local code authority to determine if an electrical outlet with a cover is required for your installation.
- Leave access to the equipment compartment for periodic spa care and maintenance.

 **WARNING: DAMAGE TO THE SPA'S EQUIPMENT COMPARTMENT COMPONENTS OR INTERNAL PLUMBING AS A RESULT OF RODENT INFESTATION IS NOT COVERED UNDER YOUR WARRANTY!**

OUTDOOR AND PATIO INSTALLATION

No matter where you install your new spa, it's important that you have a solid foundation to support it. Structural damage to the spa, resulting from incorrect installation or placement on an inadequate foundation, is not covered under the spa's limited warranty.

If you install the spa outdoors, we recommend a reinforced concrete pad at least four inches thick. The reinforcing rod or mesh in the pad should be attached to a bond wire.

DECK INSTALLATION

To be certain your deck can support your spa, you must know the deck's maximum load capacity. Consult a qualified building contractor or structural engineer. To find the weight of your spa, its contents and occupants, refer to the Spa Specification pages of this manual. This weight per square foot must not exceed the structure's rated capacity, or serious structural damage could result.

INDOOR/BASEMENT INSTALLATION

Be aware of some special requirements if you place your spa indoors. Water will accumulate around the spa, so flooring materials must provide a good grip when wet. Proper drainage is essential to prevent a build-up of water around the spa. When building a new room for the spa it is recommended that a floor drain be installed. The humidity will naturally increase with the spa installed indoors. Water may get into woodwork and produce dry rot, mildew, or other problems. Check for airborne moisture's effects on exposed wood, paper, etc. in the room. To minimize these effects, it is best to provide plenty of ventilation to the spa area. An architect can help to determine if more ventilation must be installed.

Your spa dealer can help you with local information such as zoning regulations and building codes.

WARNING: Please keep the area around your spa well ventilated when it is installed indoors or in a confined area. Inadequate ventilation around the spa could cause a build-up of a higher-than-normal concentration of spa chemicals and/or bacterial fragments. These dispersed spa chemicals and/or bacterial fragments can be inhaled, and may result in breathing difficulties or lung damage in certain people suffering from a compromised immune system or respiratory infection. If you or other bathers are affected by this condition, please seek medical attention as soon as possible.

SPA LEVELING PREPARATION

Concrete sloped at ½ inch (1.3 cm) per 10 feet (305 cm) is preferred so that rain water and water spillover will run off and not puddle underneath the spa (water under the spa for long periods of time may cause the wood to deteriorate). Other options are brick, stepping stone, or blocks.

It is important to note that soft surfaces, even when stepping stones are used to evenly distribute the weight of the spa, will have a tendency to settle, thus resulting in an unlevelled spa.

NOTE: Placing the spa on grass or dirt may increase the amount of debris which is inadvertently brought into the spa water and may cause harm to your equipment as well as the spa surface, which is not covered under warranty.

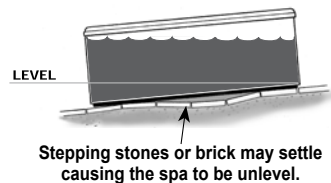
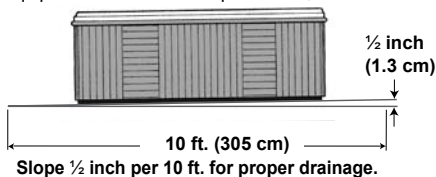

SPA LEVELING INSTRUCTIONS FOR SX & TX SPA MODELS ONLY

Approved Shim Material 1/4" to 1/2" (0.5 cm to 1.5 cm) thick, cut into 2" x 4" (5 cm x 10 cm rectangles):

- Cedar Shingles
- Exterior Rated Plywood
- Redwood
- Exterior Rated Lumber

Suggested Leveling Procedure:

1. Using a six-foot carpenter's level (or a short level and a straight piece of wood about eight feet long), check the spa to identify the lowest and highest corners.
2. With one end of the carpenter's level resting on the highest corner of the spa, and the opposite end resting on the lowest corner, gently raise the lower end of the level with shims placed on the corner of the spa shell, until a level reading is achieved.
3. Carefully lift and pivot the carpenter's level (so as not to knock over your stack of shims) to the remaining corner. The spa may be shimmed

under any of the leveling points (●) illustrated on the following page. Place the required number of shims under the end of the level at each corner and along the rounded side, until a level reading is achieved. These are now your preselected shims.

4. Carefully remove the carpenter's level and the sets of shims. With one or more persons lifting the lowest side of the spa, place a 4" x 4" (10-cm x 10 cm) block under the spa base, in the center of the side lifted.
5. Set the preselected shim sets under the wooden base support at each shimming point, as shown. Lift the spa, remove the support block, and set the spa on the shims. Repeat this procedure for the opposite side of the spa, if necessary.
6. Use the carpenter's level to recheck the level of the spa.
7. Identify the locations of any remaining shimming points using the illustration below, and carefully slide helper shims under the spa beneath each location. These helper shims should create a snug fit between the foundation and base support system. If it is necessary to lift the spa to place the helper shims, use care not to kick out the original corner shims.

SPA LEVELING INSTRUCTIONS FOR TEMPO, RELAY, STRIDE, SPRINT & DASH SPA MODELS

These spa models can not be shimmed. Make sure the pad where the spa will be placed onto is level as illustrated on the previous page. No other leveling is needed.

SPA COVER INSTALLATION

- Place the cover squarely on the spa.
- Position the tie-down locks included with your cover on the side of the spa so that they are easily reached by the cover tie-down straps. Allow for about $\frac{1}{2}$ " (1.3cm) to $\frac{3}{4}$ " (1.9cm) slack in the straps to make it easy to insert straps into locks and to compensate for vinyl shrinkage in cold weather.
- Attach the locks with the screws provided and insert the cover tie-down straps into the locks.

NOTE: Keeping the cover in place any time the spa is not in use will reduce the amount of time the heater operates, thereby minimizing operating costs.

SX (MODEL SXE)

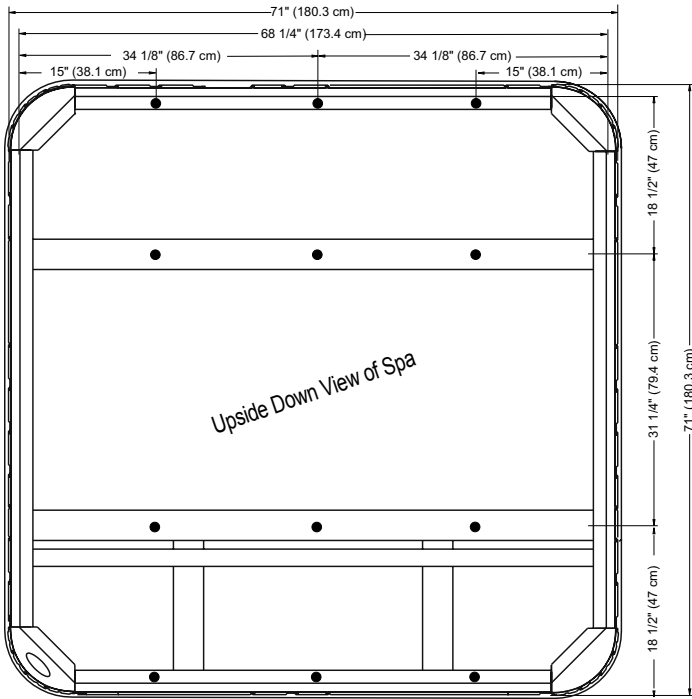

TX (MODEL TXE)

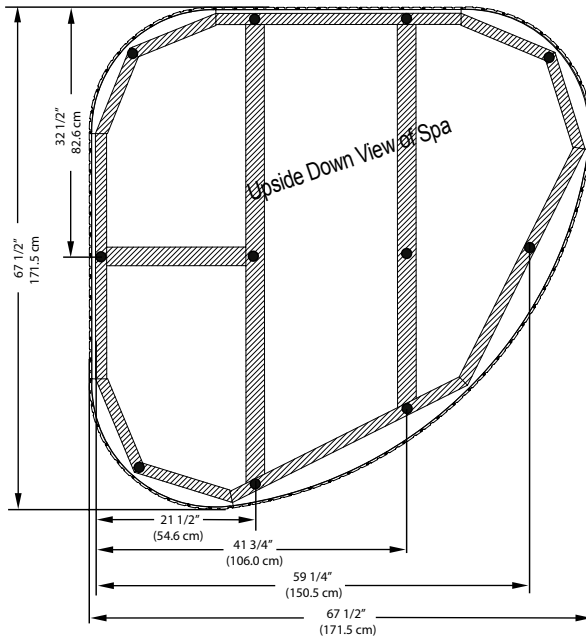

● = Shimming points of spa

ELECTRICAL INSTALLATION

ELECTRICAL REQUIREMENTS AND PRECAUTIONS

Your Hot Spot® spa has been carefully designed to give you maximum safety against electrical shock. Connecting the spa to an improperly wired circuit will negate many of the spa's safety features. Improper wiring may also cause electrocution, risk of fire, and other risks of injuries. Please read and follow the electrical installation requirements and instructions for your spa completely!

DANGER. RISK OF INJURY.

- Never leave a spa uncovered or unattended.
- Never leave a spa cover unlocked.
- Do not stand, sit, or lie on the cover.

HOT SPOT SPAS MUST BE WIRED IN ACCORDANCE WITH ALL APPLICABLE NATIONAL AND LOCAL ELECTRICAL CODES. ALL ELECTRICAL WORK SHOULD

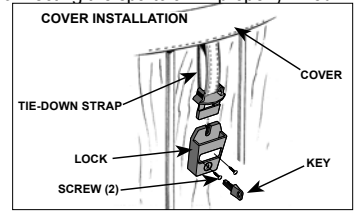

BE DONE BY AN EXPERIENCED, LICENSED ELECTRICIAN. WE RECOMMEND THE USE OF APPROPRIATE ELECTRICAL CONDUIT, FITTINGS, AND WIRE FOR ALL CIRCUITS.

The Relay™, Stride™, SX, TX, Sprint™ and Dash™ spas require a 16 amp, single phase, 240 volt, three wire service (one line, one neutral, one ground). The Tempo™ spa requires a 20 amp single phase, 240 volt, three wire service (one line, one neutral, one ground) found on the next page. Additionally, one main disconnect switch with at least 3 mm separation between contacts must be used for all electrical circuits to the spa.

The SX & TX models may be converted to 20 amp allowing the heater to run concurrent with the high speed jet pump when heat is called for.

Mount the subpanel according to local codes, but not closer than 1.5 meters (5 feet) away.

CONDUIT INSTALLATION INSTRUCTIONS

1. To connect the electrical service, first remove the screws from the equipment compartment door. Carefully pull the door panel down and away in order to remove it completely from the spa.
2. Locate the control box. Loosen the screws on the front of the control box. Remove the screws and the control box cover.
3. Route the electrical conduit through the access opening of the spa.
4. Connect the supply conduit to the control box and connect the wiring as detailed on the next page, or on the wiring diagram label on the inside of the control box cover.

⚠ **WARNING:** Removing or bypassing any GFCI breaker will result in an unsafe spa and will void the spa's warranty.

IMPORTANT: Should you ever find the need to move or relocate your Hot Spot spa, it is essential that you understand and apply these installation requirements. Your Hot Spot spa has been carefully engineered to provide maximum safety against electric shock. Remember, connecting the spa to an improperly wired circuit will negate many of its safety features.

NOTE: Long wiring runs may require larger-gauge wire than stated.

240 VOLT 50HZ SUBPANEL WIRING (SPRINT™ & DASH™ MODELS)

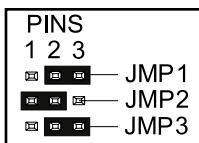
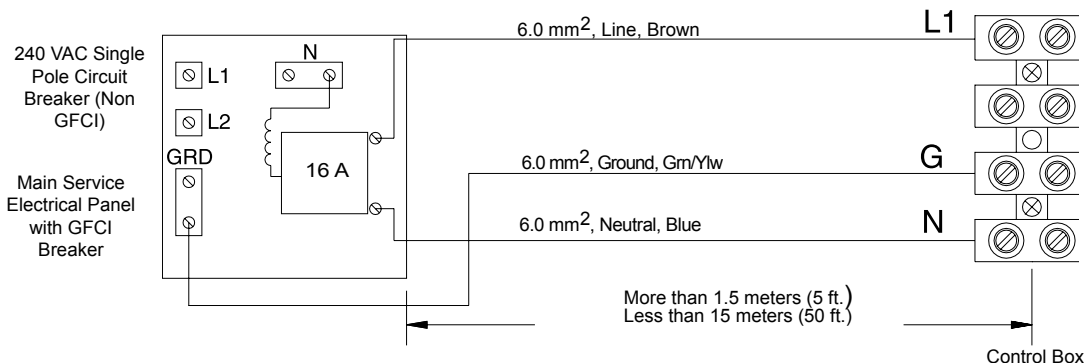

Sprint Jumper Settings

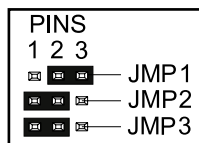

Dash Jumper Settings

240 VOLT 50HZ SUBPANEL WIRING (TEMPO™, RELAY™, STRIDE™ SX & TX MODELS)

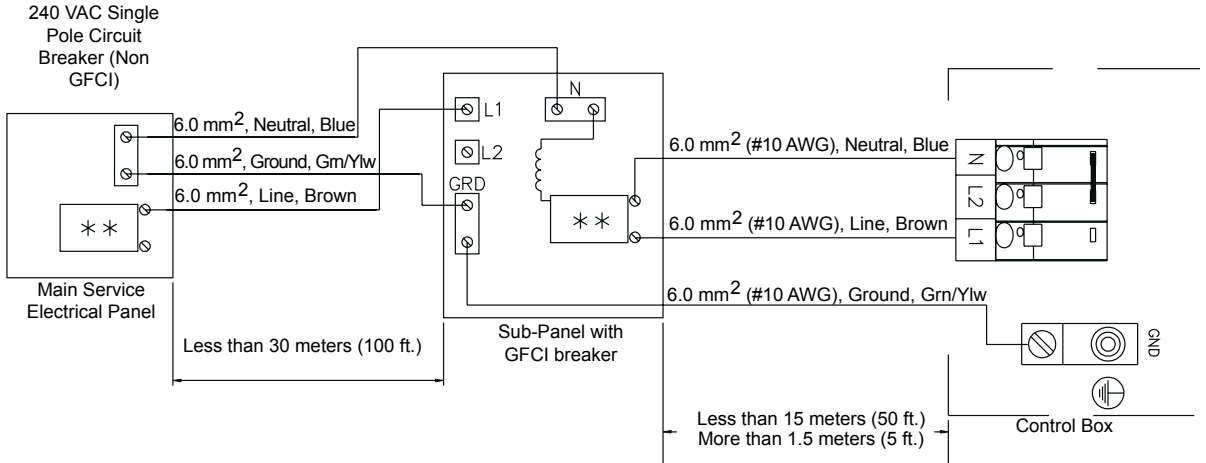

Factory Installed Settings

Tempo - 20 Amp
Relay - 16 Amp
Stride - 16 Amp
SX - 16 Amp
TX - 16 Amp

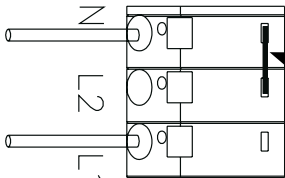

**POWER JUMPER
REQUIRED ON
ALL MODELS**

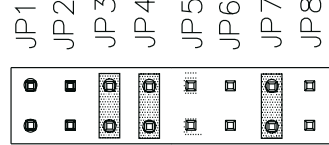

**TEMPO, RELAY & STRIDE
JUMPER CONFIGURATION**
* USED WITH STRIDE, SX & TX ONLY

Converting SX & TX to 20 Amp

SX - 20 Amp
TX - 20 Amp

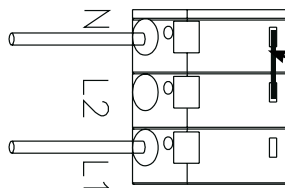

**POWER JUMPER
REQUIRED**

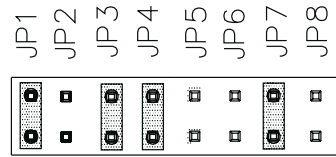

*** When Converting to 20A
Install Jumper on JP1**

SPA SPECIFICATIONS & ILLUSTRATION

TEMPO™ (MODEL TEME)

HORIZONTAL DIMENSIONS:	89" (226 cm.) square
HEIGHT (without cover):	38" (97 cm.)
EFFECTIVE FILTER AREA:	.65 sq. ft. (6.0 m ²)
HEATER:	1000 watts (1.0 kW)
WATER (capacity):	400 gallons (1514 liters)
WEIGHT:	920 lbs. dry (417 kg.), 5915 lbs. filled (2683 kg.) (Includes weight of water and 6 adults @ 175 lbs./79kg. each)
DEAD WEIGHT (filled):	115 lbs. per sq. ft., (555 kg. per m ²)
ELECTRICAL REQUIREMENTS:	240 volt 20 amp single phase G.F.C.I. circuit
NOTE:	All wiring must be performed by a licensed electrician
CERTIFICATIONS:	CE Listed

OVERHEAD VIEW

- A. Air Control Lever
- B. Control Panel
- C. Filter Compartment*
- D. Temperature Sensor
- E. Directional Precision® Jet
- F. Directional Hydromassage Jet
- G. Rotary Hydromassage
- H. Outlet for optional Ozone
- I. Drain/Suction
- J. Pillow
- K. Waterfall
- L. Waterfall On/Off Valve

*** WARNING: DO NOT SIT IN THE FILTER COMPARTMENT AREA "THIS IS NOT A SEAT"!!!**

Sitting in this area can cause:

- Restriction of filter pump suction/vacuum.
- Damage to components.

Both can result in bodily harm.

Should damage occur to components in this area, replace immediately!



RELAY™ (MODEL RELE)

HORIZONTAL DIMENSIONS:	84" (213 cm.) square
HEIGHT (without cover):	36" (91 cm.)
EFFECTIVE FILTER AREA:	.65 sq. ft. (6.0 m ²)
HEATER:	1000 watts (1.0 kW)
WATER (capacity):	360 gallons (1363 liters)
WEIGHT:	706 lbs. dry (320 kg.), 4636 lbs. filled (2103 kg.) (Includes weight of water and 6 adults @ 175 lbs./79kg. each)
DEAD WEIGHT (filled):	100 lbs. per sq. ft., (490 kg. per m ²)
ELECTRICAL REQUIREMENTS:	240 volt 16 amp single phase G.F.C.I. circuit
NOTE:	All wiring must be performed by a licensed electrician
CERTIFICATIONS:	CE Listed

OVERHEAD VIEW

- A. Air Control Lever
- B. Control Panel
- C. Filter Compartment*
- D. Temperature Sensor
- E. Directional Precision® Jets
- F. Directional Hydromassage Jet
- G. Rotary Hydromassage
- H. Outlet for optional Ozone
- I. Drain/Suction
- J. Pillow
- K. Waterfall
- L. Waterfall On/Off Valve

*** WARNING: DO NOT SIT IN THE FILTER COMPARTMENT AREA
"THIS IS NOT A SEAT"!!!**

Sitting in this area can cause:

- Restriction of filter pump suction/vacuum.
- Damage to components.

Both can result in bodily harm.

Should damage occur to components in this area, replace immediately!



STRIDE™ (MODEL STDE)

HORIZONTAL DIMENSIONS:	84" (213 cm.) x 65" (165 cm)
HEIGHT (without cover):	29" (74 cm.)
EFFECTIVE FILTER AREA:	.30 sq. ft. (2.79 m ²)
HEATER:	1000 watts (1.0 kW)
WATER (capacity):	225 gallons (852 liters)
WEIGHT:	610 lbs. dry (277 kg.), 3010 lbs. filled (1365 kg.) (Includes weight of water and 3 adults @ 175 lbs./79kg. each)
DEAD WEIGHT (filled):	80 lbs. per sq. ft., (390 kg. per m ²)
ELECTRICAL REQUIREMENTS:	240 volt 16 amp single phase G.F.C.I. circuit
NOTE:	All wiring must be performed by a licensed electrician
CERTIFICATIONS:	CE Listed

OVERHEAD VIEW

- A. Air Control Lever
- B. Control Panel
- C. Filter Compartment*
- D. Temperature Sensor
- E. Directional Precision® Jets
- F. Directional Hydromassage Jet
- G. Rotary Hydromassage
- H. Outlet for optional Ozone
- I. Drain/Suction
- J. Pillow

*** WARNING: DO NOT SIT IN THE FILTER COMPARTMENT AREA
"THIS IS NOT A SEAT"!!!**

Sitting in this area can cause:

- Restriction of filter pump suction/vacuum.
- Damage to components.

Both can result in bodily harm.

Should damage occur to components in this area, replace immediately!



SX (MODEL SXE)

HORIZONTAL DIMENSIONS: 72" (183cm.) square

HEIGHT (without cover): 33" (83.8 cm.)

EFFECTIVE FILTER AREA: 30 sq. ft. (2.79 m²)

HEATER: 1000 watts (1.0 kW)

WATER (capacity): 285 gallons (1078 liters)

WEIGHT: 525 lbs. dry (238 kg.), 3427 lbs. filled (1554 kg.)
(Includes weight of water and 3 adults @ 175/lbs/79kg. each)

DEAD WEIGHT (filled): 130 lbs. per sq. ft., 630 kg. per m²

ELECTRICAL REQUIREMENTS: 230 volt 16 amp grounded circuit (standard)

230 volt 20 amp grounded circuit (optional) - requires 20 amp breaker and control box wiring change

NOTE: All wiring must be performed by a licensed electrician.

CERTIFICATIONS: CE Listed

OVERHEAD VIEW

- A. Control Panel
- B. Spa Light
- C. Filter Lid
- D. Pillow
- E. Directional Precision® Jet
- F. Moto-Massage® Jet
- G. Air Control lever
- H. Suction
- I. Floor Drain



TX (MODEL TXE)

HORIZONTAL DIMENSIONS:	68.5" x 68.5" (174 cm x 174 cm)
HEIGHT (without cover):	29" (74 cm.)
EFFECTIVE FILTER AREA:	30 sq. ft. (2.7 m ²)
HEATER:	1000 watts (1.0 kW) @ 115V 15 amp
WATER (capacity):	140 gallons (530 liters)
WEIGHT:	365 lbs. dry (166 kg.), 1883 lbs. filled (854 kg.) (Includes weight of water and 2 adults @ 175lbs./79kg. each)
DEAD WEIGHT (filled):	100 lbs. per sq. ft., 390 kg. per m ²
ELECTRICAL REQUIREMENTS:	230 volt 16 amp grounded circuit (standard) 230 volt 20 amp grounded circuit (optional) - requires 20 amp breaker and control box wiring change
NOTE:	All wiring must be performed by a licensed electrician.
CERTIFICATIONS:	CE Listed

OVERHEAD VIEW

- A. Control Panel
- B. Spa Light
- C. Filter Lid
- D. Pillow
- E. Directional Precision® Jet
- F. Rotary Hydromassage Jet
- G. Moto-Massage® Jet
- H. Air Control lever
- I. Floor Drain
- J. Suction

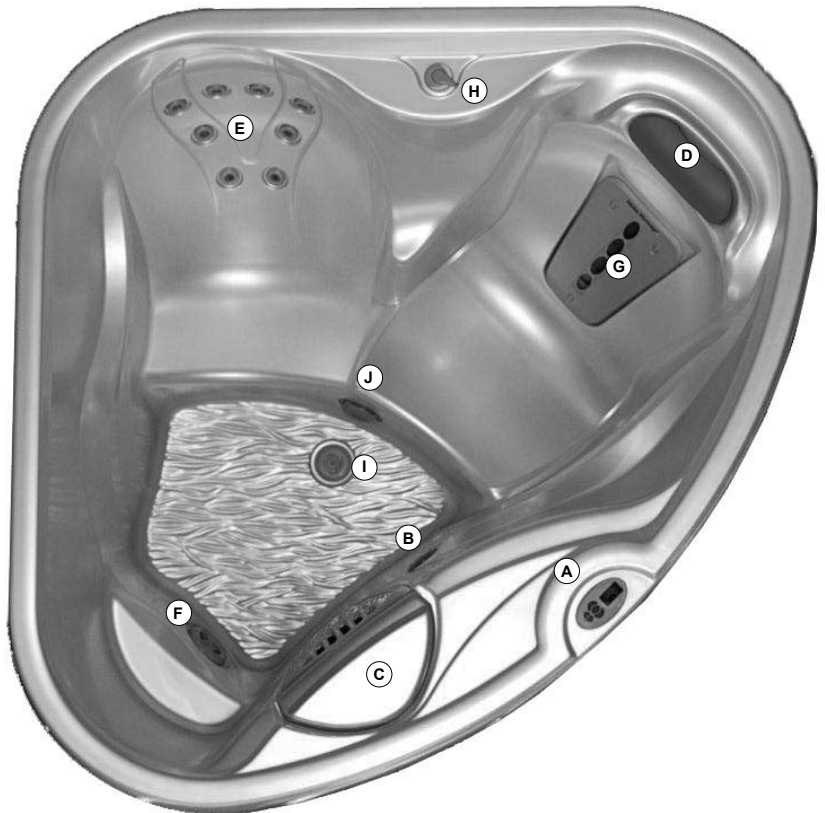

SPRINT™ (MODEL SPRE)

HORIZONTAL DIMENSIONS:	78" (198 cm.) diameter
HEIGHT (without cover):	35" (89 cm.)
EFFECTIVE FILTER AREA:	50 sq. ft. (4.65 m ²)
HEATER:	2000 watts (2.0 kW)
WATER (capacity):	280 gallons (1060 liters)
WEIGHT:	390 lbs. dry (177 kg.), 3475 lbs. filled (1576 kg.) (Includes weight of water and 6 adults @ 175 lbs./79kg. each)
DEAD WEIGHT (filled):	80 lbs. per sq. ft., (390 kg. per m ²)
ELECTRICAL REQUIREMENTS:	240 volt 16 amp single phase G.F.C.I. circuit
NOTE:	All wiring must be performed by a licensed electrician
CERTIFICATIONS:	CE Listed

OVERHEAD VIEW

- A. Control Panel
- B. Spa Light
- C. Filter Basket Lid*
- D. Temperature Sensor
- E. Directional Precision® Jet
- F. Rotary Precision Jet
- G. Directional Hydromassage Jet
- H. Rotary Hydromassage Jet
- I. Drain/Suction
- J. Outlet for optional ozone

*** WARNING: DO NOT SIT IN THE FILTER COMPARTMENT AREA "THIS IS NOT A SEAT"!!!**

Sitting in this area can cause:

- Restriction of filter pump suction/vacuum.
- Damage to components.

Both can result in bodily harm.

Should damage occur to components in this area, replace immediately!



DASH™ (MODEL DASE)

HORIZONTAL DIMENSIONS:	78" (198 cm.) diameter
HEIGHT (without cover):	35" (89 cm.)
EFFECTIVE FILTER AREA:50 sq. ft. (4.65 m ²)
HEATER:	2000 watts (2.0 kW)
WATER (capacity):	280 gallons (1060 liters)
WEIGHT:	350 lbs. dry (156 kg.), 3435 lbs. filled (1558 kg.) (Includes weight of water and 6 adults @ 175 lbs./79 kg. each)
DEAD WEIGHT (filled):80 lbs. per sq. ft., (390 kg. per m ²)
ELECTRICAL REQUIREMENTS:	240 volt 16 amp single phase G.F.C.I. circuit
NOTE:	All wiring must be performed by a licensed electrician
CERTIFICATIONS:	CE Listed

OVERHEAD VIEW

- A. Control Panel
- B. Spa Light
- C. Filter Basket Lid*
- D. Temperature Sensor
- E. Directional Precision® Jet
- F. Rotary Precision Jet
- G. Directional Hydromassage Jet
- H. Rotary Hydromassage Jet
- I. Drain/Suction
- J. Outlet for optional ozone

*** WARNING: DO NOT SIT IN THE FILTER COMPARTMENT AREA "THIS IS NOT A SEAT"!!!**

Sitting in this area can cause:

- Restriction of filter pump suction/vacuum.
- Damage to components.

Both can result in bodily harm.

Should damage occur to components in this area, replace immediately!



OPERATING INSTRUCTIONS

START-UP AND REFILL PROCEDURES

Your Hot Spot® spa has been thoroughly tested during the manufacturing process to ensure reliability and long-term customer satisfaction. A small amount of water may have remained in the plumbing after testing and, as a result, may have spotted the spa shell or the spa siding prior to delivery. Before filling the spa, wipe the spa shell clean with a soft rag.

The following instructions must be read and followed exactly to ensure a successful start-up or refill.

CAUTIONS

- Do not fill the spa with hot water, as tripping of the high-limit thermostat may result.
 - DO NOT CONNECT POWER TO AN EMPTY SPA. Power to the spa automatically activates critical components within the spa, such as controls, heater, and other systems. If power is supplied to these components prior to the spa being filled, the components will be damaged, and this may result in a non-warranty component failure.
 - Do not leave spa uncovered when filling. Solar distress can damage shell.
 - Do not use your spa after filling until all of the steps listed below are completed.
 - Do not add chlorine if treating your spa with polyhexamethylene biguanide (Biguanide, PHMB, eg. BaquaSpa®) sanitizer.
 - Before filling your spa for the first time, remove the equipment compartment door and check to ensure that the unions on either side of the pump(s) and heater are hand-tight.
1. Ensure the drain is closed. Insert the end of a garden hose into the filter compartment and begin filling the spa. The water level of your Hot Spot spa should be maintained at a level one inch above the highest jet in the spa.
RECOMMENDED: Use the Clean Screen™ pre-filter to remove unwanted contaminants from the tap water.
IMPORTANT: Watkins Manufacturing Corporation does not recommend that the spa be filled with “softened” water, as this may damage the spa’s equipment.
 2. **AFTER** the spa has been filled with water and the equipment compartment door is secured, power must be applied to the spa.
 3. The jet pump(s), heating system and all internal plumbing will achieve a partial prime as the spa is filled. To check the operation of the jet system and to purge any remaining air from the heating system, push the JETS button on the control pad twice (three times for Tempo™) to make the jet pump(s) run on high speed for one minute. Once the jet system is fully operational (as indicated by strong, non-surgings jets), priming of the spa is complete. If you do not feel a steady stream of water from your jets, refer to the instructions for priming the pump in the SPA TROUBLESHOOTING section in the back of this manual.
 4. Adjust Total Alkalinity (TA) to 80 ppm, Calcium Hardness (CH) to 100 ppm, then spa water pH to between 7.4 and 7.6. These procedures are listed in the “Water Quality and Maintenance” section.
IMPORTANT: Add spa water chemicals directly into the filter compartment after activating “Clean Cycle” for Tempo™, Relay™, Stride™, SX & TX spas only (Press SET, then JETS button). Press Jets button 3 times for Sprint™ and 2 times for Dash™ and manually shut off after 10 minutes.
OPERATION NOTE: Adjusting the Total Alkalinity as the first step is important, as out-of-balance TA will affect your ability to adjust the pH correctly and will prevent the sanitizer from operating effectively.
 5. Superchlorinate the spa water by adding 1½ teaspoons of chlorine (sodium dichlor) per 250 gallons (950 liters) of spa water. The jet pump should be running on high speed when adding the chlorine, and remain on high to circulate the spa water for a ten-minute period.
 6. Set the temperature control to the desired temperature between 100°F (38°C) and 104°F (40°C), then place the cover on the spa and allow the water temperature to stabilize (approximately 24 hours). Make sure you secure the cover in place using the cover locks. Periodically check the spa water temperature. When the water temperature climbs above 90°F (32°C), proceed to the next step.
 7. Press the JETS button three times (twice for Dash) and run the pump(s) on high for 10 minutes to circulate the spa water. After the filter cycle is complete, test the spa water for Free Available Chlorine (FAC) residual. If the residual is between 3 and 5 ppm on the test strips (found in most chemical test kits) go on to the next step. If the residual is less than 3 ppm, superchlorinate the spa water by adding 1½ teaspoons of chlorine (sodium dichlor) per 250 gallons (950 liters) of spa water, while the jet pump is running on high. Run the jet pump on high to circulate the spa water for a ten-minute period.
 8. Recheck the Total Alkalinity (TA) at 80 ppm, Calcium Hardness (CH) at 100 ppm, then spa water pH at between 7.4 and 7.6.
OPERATION NOTE: Make sure you adjust you Total Alkalinity first, as an out-of-balance condition will affect your ability to adjust the pH correctly, and will prevent the sanitizer from operating effectively. **The spa is ready for use when the spa water has circulated and the chlorine level remains between 3 ppm and 5 ppm.**
 9. The spa temperature is pre-programmed to reach 100°F (38°C), and will normally do so within 18 to 24 hours. You may raise the water temperature by pressing the Temp Up (▲) button on the control panel, or lower it by pressing the Temp down (▼) button. After a few hours the water temperature will remain within 3°F (1.5°C) of your selected temperature.

OPERATION NOTES:

1. Your spa is equipped with a ten-minute timer delay on the heating/maintenance mode. Whenever the jet pump has been turned off (and a three-degree temperature drop has occurred) or the temperature control has been turned up, it will take ten minutes before the low speed of the jet pump and heater become activated. Always push the JETS button to turn off the jet pump when exiting the spa. The spa controller has an automatic two hour "time-out" feature should the high speed jet mode be left on inadvertently. **After two hours of continuous operation, the controller will automatically return to the maintenance/heating mode.**
2. The spa controller also has a six-hour "time-out" feature should the light be left on inadvertently. **After six hours of continuous operation, the controller will automatically turn the light off.**

HEATING AND HYDROMASSAGE SYSTEMS

The Hot Spot® spa uses a two-speed jet pump to operate its hydromassage jets and to circulate the spa water through the heating system (the Tempo™, Relay™ and Sprint™ are also equipped with a single high speed jet pump used for jets only). The low speed mode of the pump, which is activated automatically by the control thermostat, will cause the spa water to be drawn slowly in through the filter, the heater, and into the pump. The pump, in turn, will push the water back into the spa through the jets. When the JETS button is pushed one time, the spa user can activate the low speed of the jet pump. (The heater may or may not be on, depending on whether the control thermostat has indicated a demand for heat.) When the JETS button is pushed a second time, the high speed of the jet pump will be activated. (This will automatically deactivate the heater.) On the Tempo, Relay and Sprint spas, when the JETS button is pushed a third or fourth time, the heating system will not activate.

If a drop in the water temperature has occurred, the spa heater will operate simultaneously only when the jet pump is operating in low speed. When the high speed mode of the jet pump is turned off, the spa will enter a ten-minute "tranquil mode." During this time the heating system (and simultaneous operation of the jet pump at low speed) will not operate (unless the JETS button is pushed), even if the water temperature has dropped below the control setting. Once the ten-minute period has expired, the spa controller will switch to the maintenance mode and the heating system will be automatically activated.

HYDROMASSAGE JETS

The larger jets in your spa allow you to re-direct the jet stream by changing the position of the nozzle.

Regulate the force of the massage by rotating the jet face clockwise to reduce the force or counter-clockwise to increase the force. Notice that turning off the flow to some jets increases the flow to the other jets. To avoid damage to your spa's plumbing and components, **do not turn off more than half of these jets at the same time.**

PRECISION® JETS

Precision jets are small. They are designed to perform a soft, soothing massage on your feet, calf, back and shoulders. Rotate the faceplate (Sprint & Dash™ spas only) to adjust the air flowing through the jet.

The Air Control levers (Tempo, Relay & Stride models only) are used to change the air intensity of a group of Precision jets simultaneously.

AIR CONTROL SYSTEM (TEMPO, RELAY, STRIDE, SX & TX MODELS ONLY)

AIR CONTROL VALVE: Turning the air control lever to the left position allows for the same volume of air to flow to all individual jets and Precision jets simultaneously. The jet faceplate on the larger jets is then used to control the water intensity of each hydromassage jet.

NOTE: Always turn the air control lever to the right position anytime the spa is not being used. This will help make the spa operate more quietly and heat more efficiently when the vinyl cover is in place.

WATERFALL VALVE (TEMPO & RELAY MODELS ONLY)

The Tempo & Relay spas are equipped with a cascading water feature. It is activated by pressing the JETS button up to 3 times when the jets are off and turning the waterfall valve counterclockwise. The flow is regulated by turning the valve to the desired position.

When not in use turn the on/off valve to the OFF position.

MOTO-MASSAGE® JET (SX & TX MODELS ONLY)

The Moto-Massage jet automatically travels up and down in a sweeping motion, simulating the natural stroking effects of a manual massage. The intensity and speed of the Moto-Massage jet may be adjusted by turning the Air Control lever.

SAFETY EQUIPMENT

- A. **HEATER HIGH-LIMIT SWITCH:** The heater high-limit sensor is located on the heater assembly. If for any reason the internal temperature of the heater exceeds 119°F (48°C), the high-limit circuit will trip and turn off the spa. The control panel display will display - - - for the Tempo, Relay & Stride spa models and "HL" for the Sprint and Dash models. The heater high-limit may be reset when the water temperature within the heater has cooled to approximately 110°F (43°C). Reset the heater high-limit by simply disconnecting power to the spa for thirty seconds.

The cause of the overheating must be located to prevent a recurrence. The most common cause of limit-tripping is inadequate water flow through the heating system. This may be caused by an obstruction within the pump water lines (filter, pump intakes or internal plumbing), the non-function of the low-speed mode of the jet pump, or the malfunction of the control thermostat. Once the cause has been identified and corrected, and the sensor has cooled, reset spa by simply disconnecting power to the spa for thirty seconds.

- B. **PRESSURE SWITCH:** The pressure switch is located inside the control box on the heater, and is designed to prevent heater operation during a no or low flow condition. If for any reason flow through the heater is reduced or stopped, the pressure switch will trip. If the pressure switch has detected a no or low flow condition **—:—:—:—** will display for the Tempo™, Relay™ & Stride™ models and "FLO" for the Sprint™ and Dash™ spa models. The most common cases of inadequate heater flow are a dirty or clogged filter, obstruction in the plumbing lines, and non-operation of the low speed heat pump. Additionally, the control panel will display **—:—:—** for the Tempo, Relay & Stride spa models and "FLC" for the Sprint and Dash spa models if the pressure switch senses flow through the heater when the jet pump is not activated. Contact your Authorized Service Technician if displayed.
- C. **CONTROL THERMOSTAT:** The control thermostat helps regulate the temperature of the water. If for any reason something were to happen to this device, the **READY** icon on the control panel will flash for the Tempo, Relay & Stride spa models and "OH" will display for the Sprint and Dash spa models. Contact your Authorized Service Technician.

SPA CONTROL PANEL (TEMPO, RELAY, STRIDE, SX & TX MODELS)

Your control panel consists of an LED display and convenient touch pads that allow you to set the water temperature and adjust the skim/filter cycle settings, lock spa temp, lock entire spa functions, as well as control the hydrotherapy jets, and lights from spa-side.

LED DISPLAY

The LED display on your spa-side control panel continually shows the spa's actual water temperature. In certain situations, it will also display other messages. See TROUBLESHOOTING section.

SET BUTTON

Use the set button to control clean cycle, filter cycle, locking and light functions. To activate the desired mode, press the "SET" button. When the "SET" icon flashes push the applicable button. The "SET" mode ends after 3 seconds or when the "SET" icon stops flashing.

TEMPERATURE CONTROL



The set temperature range is from 80°F (27°C) to 104°F (40°C). Temperatures of any setting may rise slightly depending on the current use and condition of your spa, and on outside temperature. Whenever power is disconnected and then reconnected to the spa, the water temperature setting will automatically return to the last temperature entered into the program.

Pressing the Temp Up (▲) button displays the spa's set temperature.

To increase the set temperature, press the Temp Up (▲) button again, once for each degree of increased temperature desired. If you hold the Temp Up (▲) button down, the set temperature will increase by one degree every half second.

Pressing the Temp Down (▼) button displays the spa's set temperature. To decrease the set temperature, press the Temp Down (▼) button again, once for each degree of decreased temperature desired. If you hold the Temp Down (▼) button down, the set temperature will decrease by one degree every half second.

JET PUMP CONTROL

TEMPO & RELAY MODELS ONLY

Pressing the Jet button changes the jet pump functions, depending on the number of presses:

- 1st press: Two-speed jet pump runs on low speed
- 2nd press: Two-speed jet pump runs on high speed
- 3rd press: One and Two-speed jet pumps run on high speed
- 4th press: One-speed jet pump runs on high speed
- 5th press: Both jet pumps are off

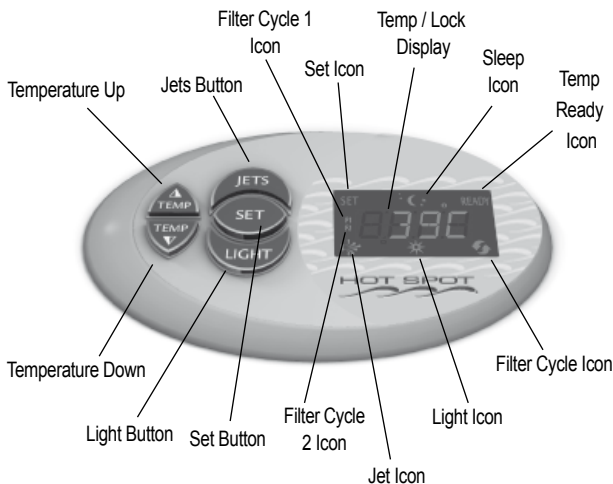

STRIDE, SX & TX MODELS ONLY:

- 1st press: Two-speed jet pump runs on low speed
- 2nd press: Two-speed jet pump runs on high speed
- 3rd press: Jet pump off

- During filter cycles or when the thermostat is calling for heat, the pump's low speed operates automatically and cannot be turned off by pressing the Temp Up (▲) or Temp Down (▼) touch pad.
- The pump on high speed automatically turns off after operating for two hours. The pump on low speed automatically turns off after operating for two hours.
- When the jets are active, the JETS Icon on the control panel will illuminate.

LIGHT CONTROL

MULTI-COLOR CONTROL (TEMPO & RELAY MODELS ONLY)



The LED lighting system allows you to brighten up your spa experience through different multi-colored lights. You can choose one stationary color or you can cycle through all the colors with the automatic color wheel. Press the LIGHT button to turn it on. The lights automatically turn off after six hours. When the lights are active, the LIGHT icon on the control panel will illuminate. Press it a second time to turn the light to a medium light intensity, a third time for a low light intensity and a fourth time will turn it off.

To activate color wheel, press the SET button followed by the LIGHT button. To select a specific color, push the LIGHT button (within 5 seconds) while the desired color is displayed. If 5 seconds have passed, after color wheel activation, you will need to press SET followed by the LIGHT button to select a specific color.

BLUE LIGHT CONTROL (SX & TX MODELS ONLY)



The SX and TX spas are equipped with a blue LED spa light. Push the LIGHT button to turn it on. Push it a second time to turn the light to a medium light intensity, a third time for a low intensity and a fourth time will turn it off. When the light is activated, the light icon in the display will illuminate.

For enhanced spa enjoyment, an optional six color wheel light feature is available to create your desired ambiance.

FILTER CYCLES



When the spa is first powered up, the automatic filter cycle will wait 10 minutes before starting. Your spa will automatically turn the first filter cycle on for 60 minutes on low speed. The second filter cycle will activate for 30 minutes, 12 hours later. The filter cycle icon, F1 or F2 will be displayed in the control panel.

NOTE: The optional FreshWater® III ozone system only works during the filter cycle.

To modify the length of either filter cycle:

- Press and hold the SET button for approximately three seconds.
- Press the LIGHT button to select filter cycle 1 or 2 (F1 or F2 will be displayed).
- Using the Temp Up (▲) or the Temp Down (▼) button, adjust the value as desired, from 0 to 6 hours.
- After program is entered it will take 10 seconds to save. Once saved, the display will then revert back to Temperature display.

The filter cycle will activate the jet pump on low speed for the entire cycle. When activated, the filter cycle icon on the display is turned on. If the temperature exceeds the set point by three degrees F for more than three hours, the system will cancel the FILTER cycle and the filter icon will



blink for the remaining filter cycle time. Should the temperature cool down to 1.5 degrees F (1 degree C) below the set point before the end of the cycle, the cycle will resume for the rest of the time. Should you use the spa during the filter cycle by placing the jet pump on high speed, the FILTER icon will blink. Once the jet pump has been shut off, a ten minute tranquil mode begins (FILTER icon will be blinking during tranquil mode) before the filter cycle will resume. The blinking filter icon indicates that the filter cycle timer is still counting, but the cycle has been temporarily interrupted.

CLEAN CYCLE



The clean cycle has been provided as a convenient timer for water maintenance. When the clean cycle is initiated, the Jet pump will activate in high speed. The jet pump icons will flash on and off until the cleaning cycle is complete. The total cleaning cycle time is ten minutes. If the clean cycle does not engage, make sure the SPA LOCK is deactivated (for Spa Lock information refer to Locking Features Section). To activate the clean cycle, press the SET button followed by the JETS button.

SLEEP MODE

The Sleep Mode operation is a feature that minimizes pump operation during quiet evening hours. For example, if Filter Cycle 1 (F1) is set to



activate at 8:00 a.m., by default, Filter Cycle 2 (F2) will activate at 8:00 p.m. (12 hours later). During 8:00 p.m. to 8:00 a.m., if the spa should call for heat, the pump and heater will activate to heat the spa under normal temperature demand. However, when in Sleep Mode, should the spa call for heat, the pump and heater will be suspended after Filter Cycle 2 (F2) until the activation of Filter Cycle 1 (F1), at 8:00 a.m. to minimize pump activation during quiet evening hours.

Important: Power-up of the spa starts the F1 sequence. In order for the sleep mode to work in the evening hours, the spa must be powered up in the early morning hours. The Sleep Mode will always be active the 6-12 hours between the end of (F2) and the beginning of (F1) depending on how the filter cycle program is set.

Note: If water temperature drops below 80° F (27° C), heater will automatically activate to prevent spa from freezing.

To activate Sleep Mode feature, press and hold Temp Up (▲) & Temp Down (▼) buttons together for 3 seconds. This will activate the feature and override the normal temperature demand. When these buttons have been engaged, a moon & stars icon (Sleep Icon) will appear in the display of the control panel, indicating this feature has been activated. To deactivate this feature, simply press and hold Temp Up (▲) & Temp Down (▼) buttons together for 3 seconds once again.

LOCKING FEATURES

The locking features, TEMPERATURE LOCK and SPA LOCK, are enabled from the control panel by a specific combination of buttons. Once enabled, a lock will remain active until the specific button combination is applied to disable the lock. Even if power is disconnected from the spa and soon thereafter reappplied (such as a power outage), the lock will remain in place.

SPA LOCK

The spa lock feature deactivates all of the functions of the control panel. It is generally used to prevent unwanted use of the spa.

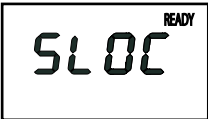

To activate the spa lock, press SET button. When the SET icon flashes press the Temp Down (▼) button. Do not press any other button on the control panel until the SET icon stops flashing. SLOC is then displayed.

To deactivate the Spa Lock, press SET button. When the SET icon flashes press Temp Down (▼) button. Do not press any other button on the control panel until the SET icon stops flashing. The SLOC is no longer displayed.

TEMPERATURE LOCK



The temperature lock feature deactivates the temperature control function from the control panel. All other functions on the control panel will operate normally. Temperature Lock is most often used by those who do not want others to change the set temperature of the spa water.

To activate the temperature lock, press SET button. When the SET icon flashes press the Temp Up (▲) button. Do not press any other button on the control panel until the SET icon stops flashing. tLOC is then displayed.

To deactivate the temperature lock, press SET button. When the SET icon flashes press the Temp Up (▲) button. Do not press any other button on the control panel until the SET icon stops flashing. The tLOC is no longer displayed.

SPA CONTROL PANEL (SPRINT™ & DASH™ MODELS)

Your control panel consists of an LED display and convenient touch pads that allow you to set the water temperature and adjust the skim/filter cycle settings as well as control the hydrotherapy jets, and light from spa-side.

LED DISPLAY

The LED display on your spa-side control panel continually shows the spa's actual water temperature. In certain situations, it will also display other messages. See TROUBLESHOOTING section.

TEMPERATURE CONTROL

The set temperature range is from 60°F (15.5°C) to 104°F (40°C). Temperatures of any setting may rise slightly depending on the current use and condition of your spa, and on outside temperature. Whenever

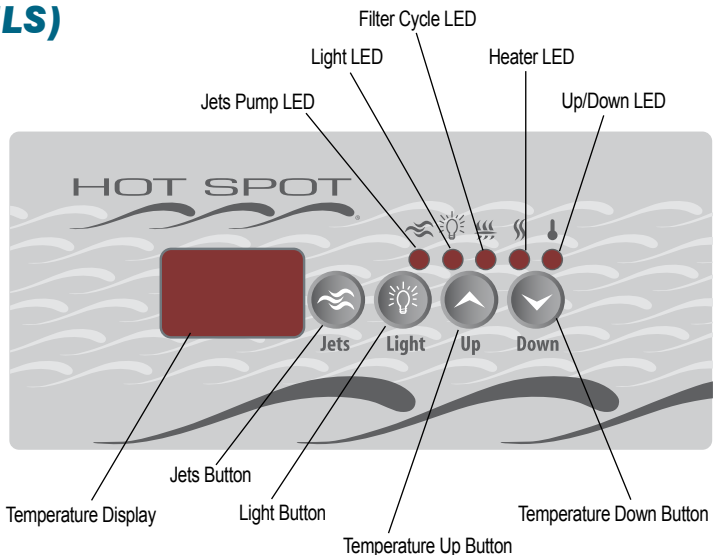

power is disconnected and then reconnected to the spa, the water temperature setting will automatically return to the default temp of 100° F (38°).

Pressing the Up (▲) button displays the spa's set temperature and illuminates the Up/Down LED for 3 seconds. To increase the set temperature, press the Up (▲) button again (before the Up/Down LED turns off) once for each degree of increased temperature desired. If you hold the button down, the set temperature will increase by one degree every half second.

Pressing the Down (▼) button displays the spa's set temperature and illuminates the Up/Down LED. To decrease the set temperature, press the Down (▼) button again (before the Up/Down LED turns off) once for each degree of decreased temperature desired. If you hold the button down, the set temperature will decrease by one degree every half second.

The Heater LED will illuminate when the Heater is on. If the Heater LED flashes on and off, this indicates there is a call for heat but the heater is not yet on.

JET PUMP CONTROL

Pressing the Jet button changes the jet pump functions, depending on the number of presses:

SPRINT™ SPA ONLY:

- 1st press: Two-speed jet pump runs on low speed
- 2nd press: Two-speed jet pump runs on high speed
- 3rd press: One and Two-speed jet pumps run on high speed
- 4th press: One-speed jet pump runs on high speed
- 5th press: Both jet pumps are off.

DASH™ SPA ONLY:

- 1st press: Two-speed jet pump runs on low speed
- 2nd press: Two-speed jet pump runs on high speed
- 3rd press: Jet pump off

- During filter cycles or when the thermostat is calling for heat, the pump's low speed operates automatically and cannot be turned off by pressing the Up (▲) or Down (▼) touch pad.
- The pump on high speed automatically turns off after operating for two hours. The pump on low speed automatically turns off after operating for two hours.
- When the jets are active, the JETS Icon on the control panel will illuminate.

LIGHT CONTROL

Your Hot Spot® Sprint and Dash are equipped with a blue LED spa light. Press the LIGHT button to turn it on. Press it a second time to turn it off. The light automatically turns off after six hours. When the light is active, the LIGHT LED on the control panel will illuminate.

FILTER CYCLES

Your spa will automatically turn the filter cycle on twice each day. When the spa is first powered up the automatic filter cycle will wait 12 hours before starting. A one hour filter cycle using the low speed of the jet pump is the programmed default filter cycle time. The filter cycle occurs twice a day (every 12 hours).

To modify the length of the filter cycle:

- A. Press and hold the light button for approximately five seconds until the display shows "xx" where xx is a number from 0-12. This is the length of the filter time.
- B. Using the Up (▲) or Down (▼), adjust the value as desired.
- C. Pressing the LIGHT button again confirms the setting and starts a cycle immediately.
- D. If the LIGHT button is not pressed again, the new filter time is stored, but the cycle is started at the next scheduled time.

The filter cycle will activate the jet pump on low speed for the entire cycle. When activated, the filter cycle LED on the display is turned on. If the temperature exceeds the set point by three degrees F for more than three hours, the system will cancel the FILTER cycle and the FILTER LED will blink for the remaining filter cycle time. Should the temperature cool down to two degrees F below the set point before the end of the cycle, the cycle will resume for the rest of the time. Should you use the spa during the filter cycle by placing the jet pump on high speed, the FILTER LED will blink. Once the jet pump has been shut off, a ten minute tranquil mode begins (FILTER LED will be blinking during tranquil mode) before the filter cycle will resume. The blinking filter LED indicates that the filter cycle timer is still counting, but the cycle has been temporarily interrupted.

NOTE: The interrupted time of a filter cycle is not extended after the filter cycle resumes. Power interruptions of the spa will reset the filter cycle to the default one hour cycle time and begin 12 hours after spa regains power.

TEMPO™ (MODEL TEME) JET SYSTEM MENU



JET PUMP 1

- 2 Directional Hydromassage Jets on back wall
- 1 Water Feature
- 6 Directional Precision Jets in Lounge (foot jets)
- 4 Directional Precision Jets in Lounge (calf jets)
- 1 Directional Hydromassage Jet, 2 Rotary Hydromassage Jets and 4 Directional Precision Jets in lounge
- 2 Directional Precision Jets and 1 Directional Hydromassage Jet on left wall



JET PUMP 2

- 10 Directional Precision Jets on left back wall
- 4 Directional Precision Jets and 2 Rotary Hydromassage Jets on back right wall
- 2 Directional Hydromassage Jets and 1 Directional Precision Jet on right wall
- 4 Directional Precision Jets in footwell

RELAY™ (MODEL RELE) JET SYSTEM MENU



JET PUMP 1

- 8 Directional Precision® Jets on back left wall
- 2 Directional Hydromassage Jets on back wall
- 1 Water feature
- 3 Directional Precision Jets on right wall
- 2 Directional Precision Jets and 1 Directional Hydromassage Jet on left wall
- 2 Directional Precision Jets in footwell



JET PUMP 2

- 4 Directional Precision Jets and 2 Rotary Hydromassage Jets on back right wall
- 4 Directional Precision Jets in Lounge (calf jets)
- 2 Directional Hydromassage Jets, 1 Rotary Hydromassage Jet and 2 Directional Precision Jets in lounge
- 2 Directional Precision Jets in footwell

STRIDE™ (MODEL STDE) JET SYSTEM MENU

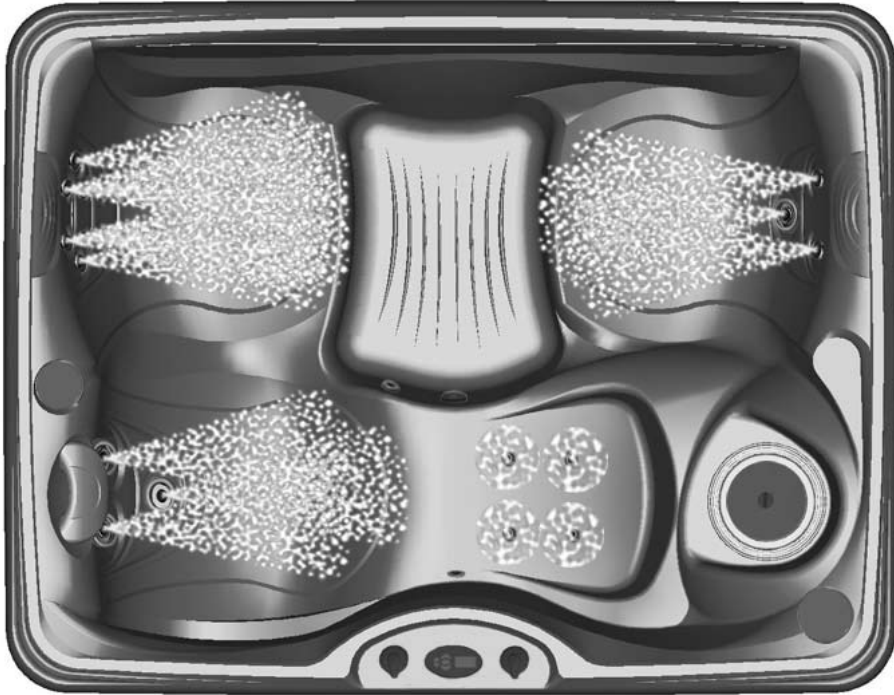

JET SYSTEM

- 8 Directional Precision Jets on back left wall
- 2 Directional Precision Jets and 1 Directional Hydromassage Jet on back right wall
- 4 Directional Precision Jets in Lounge (calf jets)
- 2 Directional Hydromassage Jets and 1 Rotary Hydromassage Jet in lounge

SX (MODEL SXE) JET SYSTEM MENU



JET SYSTEM

- 8 Directional Precision® Jets on back Left wall.
- 1 Moto-Massage® Jet on right back wall.
- 2 Directional Precision Jets on front right wall.
- 2 Directional Precision Jets in front left footwell.

TX (MODEL TXE) JET SYSTEM MENU



JET SYSTEM

- 8 Directional Precision® Jets on left back wall.
- 1 Moto-Massage® Jet on right back wall.
- 1 Rotary Hydromassage Jet in front left footwell.

SPRINT™ (MODEL SPRE) JET SYSTEM MENU



JET PUMP 1

- 4 Directional Precision® Jets, 4 Rotary Precision Jets and 1 Directional Hydromassage Jet on back right wall
- 6 Directional Precision Jets and 2 Rotary Precision Jets on back left wall



JET PUMP 2

- 4 Directional Precision Jets, 2 Rotational Hydromassage Jets and 1 Directional Hydromassage Jet on back wall
- 2 Directional Hydromassage Jets on front right wall
- 2 Directional Hydromassage Jets and 2 Rotary Precision Jets on front left wall

DASH™ (MODEL DASE) JET SYSTEM MENU



JET SYSTEM

- 2 Rotary Precision® Jets on and 2 Directional Hydromassage Jets on back wall
- 2 Directional Hydromassage Jets on back right wall
- 1 Rotary Hydromassage Jet and 2 Directional Precision Jets on front right wall
- 2 Rotary Precision Jets and 1 Directional Precision Jet on front left wall
- 4 Directional Precision Jets and 1 Rotary Precision Jet on back left wall

WATER QUALITY AND MAINTENANCE

It's important to have clean, sanitized water. Water maintenance is one of the least understood, yet most important areas of spa ownership. Your dealer can guide you through the process of achieving and maintaining perfect water in your spa, given your local conditions. Your program will depend on your water's mineral content, how often you use your spa, and how many people use it.

Watkins recommends that you either use an entirely chlorine-based system, or an alternative system which uses silver ions (the FreshWater_{Ag+}[®] silver ion purifier). Hot Spring[®] FreshWater[®] products, which Watkins recommends, are available from authorized Hot Spot[®] dealers.

GENERAL INFORMATION

THE THREE FUNDAMENTAL AREAS OF WATER MAINTENANCE:

- **Water Filtration**
- **Water Sanitation**
- **Chemical Balance/pH Control**

Water sanitation is the responsibility of the spa owner, achieved through the regular and periodic (daily, if necessary) addition of an approved sanitizer. The sanitizer will chemically control the bacteria and viruses present in the fill water or introduced during use of the spa. Bacteria and viruses can grow quickly in undersanitized spa water.

The water's chemical balance and pH control are also the responsibility of the spa owner. You'll have to add chemicals to maintain proper levels of Total Alkalinity (TA), Calcium Hardness (CH) and pH. Proper water balance and pH control will minimize scale buildup, extend the life of the spa, and allow the sanitizer to work at top efficiency.

METHODS FOR TESTING THE SPA WATER

Accurate water testing and analysis is an important part of effectively managing your spa water. You must have the ability to test for:

- Total Alkalinity (TA)
- Calcium Hardness (CH)
- pH
- Sanitizer

Two types of testing methods are recognized and recommended by Watkins:

The Reagent Test Kit is a method which provides a high level of accuracy. The reagents come in either liquid or tablet form.

FreshWater[®] Test Strips are a convenient testing method used by many spa owners.

IMPORTANT: Always read and carefully follow the directions included with the Test Kit or Test Strips to ensure the accuracy of the test results.

BASIC CHEMICAL SAFETY

When using chemicals, read the labels carefully and follow directions precisely. Though chemicals protect you and your spa when used correctly, they can be hazardous in concentrated form. Always observe the following guidelines:

- Allow only a responsible person to handle spa chemicals. Keep them out of the reach of children.
- Accurately measure the exact quantities specified, never more. Do not overdose your spa.
- Handle all containers with care. Store in a cool, dry, well ventilated place.
- Always keep chemical containers closed when not in use. Replace caps on their proper containers.
- Follow the emergency advice on the product label in case of accidental contact, or if the chemical is swallowed. Call a doctor or the local Poison Control Center. If a doctor is needed, take the product container along so that the substance can be identified.
- Don't inhale fumes or allow chemicals to come in contact with your eyes, nose, or mouth. Wash your hands immediately after use.
- Don't let chemicals get on surrounding surfaces or landscaping.
- Don't use a vacuum cleaner to clean up chemical spills.
- Never smoke around chemicals. Some fumes can be highly flammable.
- Don't store any chemicals in the spa equipment compartment.

HOW TO ADD CHEMICALS TO THE WATER

IMPORTANT: All spa water chemicals including MPS (shock), chlorine, granulated pH increaser or decreaser, granulated total alkalinity increaser, calcium hardness increaser, liquid stain and scale inhibitor, and liquid defoamer must always be added directly into the filter compartment while the jet pump is running in high speed mode, and it must run for a minimum of ten minutes.

TO ADMINISTER SPA WATER CHEMICALS:

1. Fold back the spa cover.
2. Push the JET button twice to activate the jet pump's high speed mode.
3. Carefully measure the recommended amount of chemical and slowly pour it into the filter compartment. Use care not to splash chemicals on your hands, in your eyes, on the spa shell surface or on the siding.
4. After ten minutes, shut off the jet pump and close and lock the cover to complete the procedure. **Risk of Drowning:** Never leave an open spa unattended!

⚠ **WARNING:** High sanitizer levels can cause discomfort to the user's eyes, lungs and skin. Always allow the sanitizer level to fall to the recommended range before using the spa.

NOTE: After administering a super chlorination treatment or non-chlorine shock to your spa, leave the cover open for a minimum of twenty minutes to allow the oxidizer gas to vent. A high concentration of trapped oxidizer gas which may exist as a result of the shock treatment (not daily sanitation) may eventually cause discoloration or vinyl degradation to the bottom of the cover. This type of damage is considered chemical abuse and is not covered under the terms of the limited warranty.

THE HOT SPOT® SPA WATER MAINTENANCE PROGRAM

Each step in your water maintenance program is dependent on the completion of the previous steps. Omitting a step or failing to reach the recommended range may cause an imbalance in your water's chemistry. Unbalanced water chemistry can damage the spa and its components as well as cause discomfort for the user.

FILLING THE SPA WITH WATER

- A. To prevent contaminants from entering the spa, Watkins Manufacturing Corporation recommends using the Clean Screen™ pre-filter when filling the spa with water. Always fill the spa through the filter compartment.
- B. The Clean Screen pre-filter is designed to remove unwanted contaminants such as rust, dirt, detergents and algae as well as iron, copper and magnesium from the fill water. Dissolved minerals and metals such as lead and calcium are not removed.
- C. Instructions are included with the Clean Screen pre-filter. When the spa is filled, proceed to the Start-Up and Refill Procedures on page 11.

BALANCING THE TOTAL ALKALINITY (TA)

- A. The recommended Total Alkalinity (TA) for your spa water is 40-120 ppm.
- B. Total Alkalinity is a measure of the total levels of carbonates, bicarbonates, hydroxides, and other alkaline substances in the water. TA is referred to as the water's "pH buffer". In other words, it's a measure of the ability of the water to resist changes in pH level.
- C. If the TA is too low, the pH level will fluctuate widely from high to low. Fluctuations in pH can cause corrosion or scaling of the spa components. **Low TA can be corrected by adding Hot Spring® FreshWater® pH/Alkalinity Up or sodium hydrogen carbonate.**
- D. If the Total Alkalinity is too high, the pH level will tend to be high and may be difficult to bring down. **It can be lowered by adding Hot Spring FreshWater pH/Alkalinity Down or sodium bisulfate.**
- E. Once the TA is balanced, it normally remains stable, although the addition of more water with a high or low alkalinity will raise or lower the TA reading of the water.
- F. When the Total Alkalinity is within the recommended range, proceed to the next step.

BALANCING THE CALCIUM HARDNESS (CH)

- A. The recommended Calcium Hardness (CH) level for your spa is 50-150 ppm.
- B. Calcium Hardness is a measure of the total amount of dissolved calcium in the water. Calcium helps control the corrosive nature of the spa's water. That's why calcium-low water (commonly known as "soft" water) is not recommended. It is very corrosive to the equipment, and can cause staining of the spa shell. If the calcium level is too low, we recommend using HotSpring FreshWater Calcium Increaser to bring the calcium hardness level to within the recommended range.
- C. If the CH is too high (commonly known as "hard" water), formation of scale on the spa's shell surface and equipment can result. **CH can be decreased by using the Vanishing Act™ Calcium Remover available from your Hot Spot dealer.** [Additionally, a stain and scale inhibitor, such as Hot Spring FreshWater Stain and Scale Defense, should be added to the spa water, according to label instructions.]
- D. Once the CH is balanced, it normally remains stable, although the addition of more water with a high or low calcium content will raise or lower the CH reading of the water.
- E. When the Calcium Hardness is within the recommended range, proceed to the next step.

BALANCING THE pH

- A. The ideal pH level for your spa water is 7.4-7.6.
- B. The pH level is the measure of acidity and alkalinity. Values above 7 are alkaline; those below 7 are acidic. Maintaining the proper pH level is extremely important for:
- Optimizing the effectiveness of the sanitizer.
 - Maintaining water that is comfortable for the user.
 - Preventing equipment deterioration.
- C. If the spa water's pH level is too low, the following may result:
- The sanitizer will dissipate rapidly.
 - The water may become irritating to spa users.
 - The spa's equipment may corrode.

If the pH is too low, it can be increased by adding sodium hydrogen carbonate, or

Hot Spring® FreshWater® pH/Alkalinity Up, to the spa water.

- D. If the pH level is too high, the following may result:
- The sanitizer is less effective.
 - Scale will form on the spa shell surface and the equipment.
 - The water may become cloudy.
 - The filter cartridge pores may become obstructed.

If the pH is too high, it can be decreased by adding sodium bisulfate, or Hot Spring FreshWater pH/Alkalinity Down, to the spa water.

NOTE: After adding sodium hydrogen carbonate, or sodium bisulfate, **wait two hours** before testing the water for pH. Measurements taken too soon may not be accurate.

- E. It is important to check the pH on a regular (weekly) basis. The pH will be affected by the bather load, the addition of new water, the addition of various chemicals, and the type of sanitizer used.
- F. When the pH is within the recommended range, proceed to the final step.

ALKALINE TUB WATER (SCALING ZONE)	8.2	ADD pH DECREASER TO LOWER pH
	7.8	
	7.6	
COMFORT ZONE	7.4	IDEAL
ACIDIC TUB WATER (CORROSIVE ZONE)	7.2	ADD pH INCREASER TO RAISE pH
	6.8	
	pH	

MAINTAINING THE SANITIZER LEVEL

- A. Sanitizer is extremely important for killing algae, bacteria and viruses, and preventing unwanted organisms from growing in the spa. At the same time, you don't want too high a sanitizer level, or it can irritate your skin, lungs and eyes.
- B. Always maintain the sanitizer level in your spa at the recommended level for each type of sanitizer.
- C. Watkins recommends the following sanitizers:
- Sodium Dichloro-s-Triazinetrione (sodium dichlor or chlorine)
 - BaquaSpa® (please consult your BaquaSpa manual for instructions on the use of this product).
 - Brominating Concentrate (one step granular bromine)

⚠ **WARNING:** DO NOT use tri-chlor chlorine, bromo-chloro-dimethyl-hydantoin (BCDMH), or any type of compressed bromine or chlorine, acid, or any type of sanitizer which is not recommended by Watkins Manufacturing Corporation.

THE WATKINS WATER MAINTENANCE QUICK REFERENCE GUIDE					
Steps	Ideal Range (ppm)		What Chemicals to Use		
	Min.	Max.	To Raise	To Lower	
1 Total Alkalinity	40	120	Sodium Hydrogen Carbonate, or Sodium Bicarbonate	Sodium Bisulfate	
2 Calcium Hardness	50	150	Calcium Hardness Increaser	Use a mixture of 75% hard water and 25% soft water or use a Stain and Scale Inhibitor	
3 pH	7.4	7.6	Sodium Bisulfate		
4 Sanitizer	See section on Maintaining the Sanitizer Level				

FRESHWATER AG+[®] SILVER ION SYSTEM

The Silver ion system is comprised of the following products:

- Sodium Dichlor
- Monopersulfate (MPS)
- FreshWater_{Ag+}[®] silver ion purifier (part # 73770 is required in order to use it on the Sprint™ and Dash™ models).
- Clean Screen™ Pre-filter

Clean Screen Pre-filter is used when filling a spa for the first time, at top off, or at refill. It attaches to a garden hose and filters out rust, dirt, detergents, algae and chemicals.

Sodium Dichlor (chlorine) is the only recommended sanitizer that will work in conjunction with all of the other products in this system..

Monopersulfate (MPS) is an oxidizing chemical used to prevent the buildup of contaminants, maximize sanitizer efficiency, minimize combined chlorine, and improve water clarity.

HOT SPOT WATER TREATMENT GUIDE

At spa startup or refill	Follow Start-Up and Refill Procedures section	
Prior to each use (Test before adding any chemicals; do not add any chemicals if proper or higher levels are found.)	Add one-half (½) teaspoon of chlorine per 250-gallons (950 liters) Tempo™ ¼ teaspoon Relay™ ¾ teaspoon Stride™ ½ teaspoon SX ⅔ teaspoon TX ¼ teaspoon Sprint™ ½ teaspoon Dash™ ½ teaspoon	Add one (1) tablespoon of monopersulfate (MPS)* per 250-gallons (950 liters). Tempo 1½ tablespoons Relay 1½ tablespoons Stride 1 tablespoon SX 1¼ tablespoons TX ½ tablespoon Sprint 1 tablespoon Dash 1 tablespoon
Once a week	Add one and one-half (1½) teaspoons of chlorine per 250-gallons (950 liters). Tempo 2¼ teaspoons Relay 2¼ teaspoons Stride 1 teaspoon SX 1¾ teaspoons TX ¾ teaspoons Sprint 1 teaspoon Dash 1 teaspoon	Add three (3) tablespoons of monopersulfate (MPS)* per 250-gallons (950 liters). Tempo 4½ tablespoons Relay 4½ tablespoons Stride 3 tablespoons SX 3¾ tablespoons TX 1½ tablespoons Sprint 3 tablespoons Dash 3 tablespoons
Every four months	Drain spa, replace cartridge (if applicable), and refill your spa. Follow spa Start-Up and Refill Procedures	
As needed (if water is hazy, cloudy or has an odor)	Add one and one half (1½) teaspoons of sodium dichlor per 250-gallons (950 liters). Tempo 2¼ teaspoons Relay 2¼ teaspoons Stride 1 teaspoon SX 1¾ teaspoons TX ¾ teaspoons Sprint 1 teaspoon Dash 1 teaspoon	

*MPS is an oxidizer, not a sanitizer

FreshWater_{Ag+}[®] silver ion purifier introduces silver ions into the spa water, inhibiting bacteria growth. When combined with MPS, or chlorine, oxidizes particulates in the spa water.

It is important to follow the recommended application and maintenance programs outlined for each product's use.

If the spa is being used over an extended period of time, such as a whole afternoon or evening, additional sanitizer will be needed. **A weekly "shock treatment" is required.**

The shock treatment quickly destroys any remaining contaminants while revitalizing the silver ion cartridge, allowing the silver ions to continue to be released into the water. Without this weekly shock treatment, the silver ion cartridge may stop releasing silver ions into the water.

To weekly "shock treat" your spa you may use either MPS or sodium dichlor. It will require much less sodium dichlor to administer the shock treatment than MPS (one teaspoon of sodium dichlor has oxidizing capabilities comparable to two tablespoons of MPS). Sodium dichlor may be a more appropriate weekly shock for those users that experience heavy bather load conditions.

EVERFRESH[®] WATER CARE SYSTEM

The EverFresh water care system is comprised of the FreshWater_{Ag+} Silver ion and the FreshWater III high output ozone system

FreshWater Ag+ silver ion System (see above).

FreshWater III high output ozone system (Optional) uses Corona Discharge technology to produce a high concentration of ozone, which is injected into the spa water

FRESHWATER_{Ag+} SILVER ION PURIFIER REPLACEMENT INSTRUCTIONS

When replacing the FreshWater_{Ag+} silver ion purifier (every four months) it is highly recommended that the spa be drained and refilled at the same time. After refilling the spa with water, balance the Total Alkalinity (TA), Calcium Hardness (CH) and pH to the recommended levels. Shock the spa by adding sodium dichlor (See Sanitization Table for details).

1. Fold back the vinyl cover.
2. Remove any floating items within the filter compartment.
3. Locate the filter retainer handle. Turn the filter retain handle counterclockwise until the cap can be removed from the filter standpipe. For Sprint & Dash models, remove the filter cap and basket with Silver Ion attached.
4. Remove and clean filter cartridges.
NOTE: When replacing the FreshWater_{Ag+} silver ion purifier, it is an excellent time to clean the filter to extend the life. Remove the existing FreshWater_{Ag+} silver ion purifier.
5. Install the new FreshWater_{Ag+} silver ion purifier into the filter standpipe as illustrated in the Silver Ion instructions (attach to bottom of basket on Sprint & Dash models only).
6. Reinstall the cleaned filter cartridges.
7. Replace and secure the filter retainer handle or filter basket and cap.
8. Fold the cover back into place.

⚠ **WARNING:** Never use the spa with the filter cartridge or filter standpipe removed!

SILVER IONS QUESTIONS AND ANSWERS

Question: How are the silver ions actually added to the water?

Answer: The silver ion cartridge contains ceramic beads that are infused with silver. The cartridge is placed in the filter standpipe. The flowing water, through a chemical erosion process, carries with it the silver ions necessary to add a sanitizing residual to the spa water.

Question: What happens if I do not add the weekly shock treatment?

Answer: The contaminants in the water may coat the silver ion cartridge's ceramic beads, blocking the silver ions' release into the water. When this occurs, there will be no residual of silver ions present in the water, eliminating them from the sanitizing process.

Question: How often should the FreshWater_{Ag+}[®] silver ion purifier cartridge be replaced?

Answer: The cartridge must be replaced every four months. Please refer to the instructions provided with each FreshWater_{Ag+} silver ion purifier cartridge.

Question: Can I use the FreshWater[®] III ozone system in addition to the silver ion system?

Answer: Yes. In fact, it is preferred! The use of the FreshWater III ozone system will enhance the performance of the silver ions and may substantially reduce the need for supplemental chemical treatments when the spa is not in use.

Question: Why can't I use bromine or biguanides instead of MPS or chlorine?

Answer: Bromine and biguanides will chemically react with the sanitizing action of the silver ions. This will eliminate their beneficial sanitizing effect.

DOS AND DON'TS

- DO check your MPS or dichlor chemical level prior to each use.
- DO shock the spa weekly (use either MPS or sodium dichlor).
- DO change the FreshWater_{Ag+} silver ion purifier every four months.
- DO test Total Alkalinity and pH weekly.
- DO use MPS for spas only, such as Hot Spring® MPS chlorine-free oxidizer.
- DO store all chemicals in a tightly sealed container in a cool, dry place.
- DON'T use bromine, sodium bromide or biguanides. These are an active sanitizer and will combine with the silver ions to inactivate them.
- DON'T use a water clarifier. Clarifiers will cause the spa water to become cloudy.

CHLORINE (SODIUM DICHLOR)

- Sanitizing chemicals, such as chlorine, are oxidants that kill bacteria and viruses in the water. The Free Available Chlorine (FAC) is a measure of the amount of unused chlorine available to sanitize the spa. The recommended FAC for your spa water is 3.0-5.0 ppm.
- Watkins Manufacturing Corporation recommends the use of Hot Spring FreshWater Concentrated Chlorinating Granules (sodium dichlor) for sanitizing the water. Sodium dichlor is preferred because it is totally soluble, dissolves quickly and is nearly pH neutral.
- Maintaining the proper level of chlorine during use is extremely important.
- If the FAC is too low, bacteria and viruses can grow rapidly in the warm water. **Increase the FAC by adding granulated sodium dichlor.**
- If the FAC is too high, the water can cause discomfort to the user's eyes, lungs and skin. **Simply allow some time to pass. The FAC level will naturally drop over time.**
- When the Free Available Chlorine is within the recommended range, the spa is ready to be enjoyed.

⚠ **WARNING:** There are several forms of stabilized chlorine available for use in spas and swimming pools and each form has specific chemical characteristics. It is extremely important that the one you choose is specifically designed for use in spas. Use of an incorrect product such as tri-chlor, which has a very low pH (2.6), dissolves too quickly in hot water resulting in extremely high levels of chlorine, and is designed for concrete or plaster swimming pools, **WILL** cause damage to your spa. Use of a liquid or any type of compressed bromine or chlorine, acid or any type of sanitizer which is not recommended by Watkins Manufacturing Corporation **WILL** damage your spa and is specifically not covered under the terms of the limited warranty.

IMPORTANT: Granulated chlorine (sodium dichlor) will degrade if stored improperly. We recommend purchasing chlorine in one, two, or five pound containers and storing it in a cool, dry place to maintain its potency.

SUPER CHLORINATION

Super Chlorination is designed to "burn-off" the build-up of chloramines (used chlorine), to eliminate the chlorine smell and to allow the proper level of free chlorine to be maintained.

When giving your water a super chlorination treatment, open the cover at least half way for twenty minutes to allow the chlorine gas to vent off. The high concentration of chlorine gas which may exist as a result of super chlorination (not daily sanitation) may eventually cause discoloration or degradation to the bottom of the cover, which would not be covered under the terms of your warranty.

⚠ **WARNING:** There are several forms of stabilizer chlorine available for use in spas and swimming pools. Each form has specific chemical characteristics. It is extremely important that the form you choose is specifically designed for use in spas. Use of an incorrect product such as tri-chloro, which has a very low pH (2.6) dissolves too quickly in hot water resulting in extremely high levels of chlorine, and is designed for concrete or plaster swimming pools. **WILL** cause damage to your spa. Use of a liquid, or any type of compressed bromine or chlorine, acid, or any type of sanitizer which is not recommended by Watkins Manufacturing Corporation, **WILL** damage your spa and is specifically not covered under the terms of the limited warranty.

CHLORINE DPD TEST KIT OR TEST STRIP READING	5.0 —	DO NOT USE THE SPA UNTIL THE TEST KIT READING IS BELOW THIS LEVEL
	4.0 —	RECOMMENDED LEVEL SAFE
3.0 — ADD CHLORINE		
2.0 —	1.0 —	DO NOT USE SPA; ADD CHORINE TO REACH RECOMMENDED SAFE LEVEL
0 —		

SUPPLEMENTAL WATER MAINTENANCE

Proper water sanitation and mineral balance (pH control) are absolutely essential for a complete spa water maintenance program. Here are three other popular water additives that are optional:

MINERAL DEPOSIT INHIBITORS

As water evaporates from your spa and new water is added, the amount of dissolved minerals will increase. (Minimize evaporation by keeping the cover on the spa whenever possible.) The spa water may eventually become "hard" (Calcium Hardness too high) enough to damage the heater by calcifying its surface. Proper pH control can minimize this. To reduce hardness, use the Vanishing Act™ calcium remover.

Normal soap build-up will require water replacement regularly enough that mineral deposits normally are not a problem.

Occasionally, high iron or copper content in the water may produce green or brown stains on the spa. Using the Clean Screen™ pre-filter when

adding water to the spa will help to reduce these metals.

NOTE: Well water may contain high concentrations of minerals. The use of a low water volume, extra-fine pore water filter (such as the Clean Screen pre-filter) will help to remove many of the larger particles during the filling of the spa. Clean Screen pre-filters can be purchased at your local Hot Spot® Spa Dealer.

FOAM INHIBITORS

Spa water requires changing due to the build-up of soap in the water. Typically, soap will cause the spa water to foam when the jets are used. Soap is introduced into the spa water from two sources; users' bodies, which retain a soap residue after showering, and swimming apparel, which retains soap after washing.

Foam inhibitors, such as Hot Spring FreshWater Defoamer, can suppress foam, but cannot remove soap from the water. Soap is very difficult to remove from the water because soap is not oxidized by any chemical added to the spa. Only ozone can oxidize soap.

Eventually the soap build-up in the water will be concentrated, resulting in an unclean feeling on the bather's skin, which is impossible to remedy. When this occurs, it's time to drain and refill the spa. Depending on the soap input, the water should last about 4 months before needing to be drained.

OZONE (OPTIONAL)



The FreshWater® III high output ozone system is the Watkins recommended ozone purification system for your spa. The FreshWater III ozone system utilizes Corona Discharge (CD) technology to produce a higher concentration of ozone than is produced by competing ultraviolet light (UV) ozone systems.

The FreshWater III high output ozone system greatly enhances the quality of the spa water when used to supplement the spa owner's regular water maintenance program. Contrary to some information circulated throughout the pool and spa industry regarding ozone systems, ozone CAN NOT be used as a single-source sanitizer, water clarifier, anti-foamer, and mineral chelating agent. A secondary-source sanitizer must be used to maintain 2.0 ppm (2.0 mg/L) of Free Available Chlorine (FAC). Watkins Manufacturing Corporation recommends that a chemical maintenance program based on recognized and documented industry standards still be followed when using an ozone purification system to assure water sanitation and the highest quality purified water.

CLEANING THE OZONE INJECTOR

On occasion, a mineral build-up may clog the ozone injector causing a lack of flow or low flow of ozone bubbles. To prevent this, refer to the following instructions to clean the injector:

1. Disconnect power to the spa.
2. Access the equipment compartment.
3. Locate the ozonator in the equipment compartment and unplug the ozonator from the control box.

 <p>WARNING</p>	<p>Nitric acid accumulates in the air lines of the ozonator and injector. Nitric acid will cause severe chemical burns if direct skin contact is made, so always wear protective gloves, glasses and clothing when working on the ozonator or injector lines. To prevent inhalation or ingestion of the nitric acid, DO NOT blow or inhale with your mouth to any of the adapters, fittings or tubing of the ozonator or injector air lines.</p>	 <p>WARNING</p>
---	--	---

4. Place 16 ounces (1/2 liter) of white vinegar into a container such as a cup or bucket. Place the container on the equipment compartment floor.
NOTE: White vinegar will not damage any of the spa components.
5. Carefully loosen the long Tygon / Kynar tubing to the bottom of the ozonator. **A liquid substance may be found inside the tubing. If a liquid substance is present, BE CERTAIN NOT TO COME INTO CONTACT WITH THE LIQUID (SEE WARNING ABOVE).**
6. Place the end of the tubing into the vinegar, making certain that the end of the tubing sits at the bottom of the container.
7. Reconnect power to the spa.
8. Run the spa until all 16 ounces (1/2 liter) of the vinegar are gone. This should allow an ample flow of vinegar to be run through the injector and clear the blockage.
9. Disconnect power to the spa.
10. Remove the empty cup or bucket.
11. Reinstall the tubing to the bottom of the ozonator.
12. Plug the ozonator into the control box.
13. Close the equipment compartment door.
14. Reconnect power to the spa.

IMPORTANT: When using the FreshWater® III high output ozone system, the filter cycle must be activated to ensure adequate ozone circulation. Refer to the circulation cycle in the HEATING AND HYDROMASSAGE SYSTEM section for more information.

DO'S AND DON'TS

- **DO** add all chemicals slowly into the filter compartment with the jet pump operating on high speed for ten minutes.
- **DO** use special care if using baking soda to clean either the interior or exterior plastic surfaces.
- **DO** use only a granular form of sanitizer.
- **DON'T** use swimming pool (muriatic) acid to lower pH.
- **DON'T** splash pH increaser additives on the siding.
- **DON'T** use Compressed Sanitizers.

The use of bromine sticks or tablets in floaters, which may become entrapped in a lounge or cooling seat (or sink to the spa floor), have been shown to cause discoloration of or surface distress to a spa's shell.

- **DON'T** use a floater type sanitization system as a low or no maintenance solution to your spa maintenance program.

The spa shell can easily withstand the effects of a properly administered sanitizer. Floating dispensers can become trapped in one area and cause an over-sanitization (or chemical burn) of that particular area.

If the dispenser setting is too high, the high concentration can discolor the spa shell and damage the underside of the cover.

Automatic floating dispensers have a tendency to either over-brominate or under-brominate as the rate of erosion varies greatly. Damage to the spa and cover can occur very quickly.

⚠ **WARNING:** Watkins Manufacturing Corporation **DOES NOT** recommend the use of any floating chemical dispenser. Damage to the spa shell or components caused by a floating chemical dispenser is specifically not covered under the terms of the limited warranty.

- **DON'T** use a sanitizer which is not designed for spas.
- **DON'T** use household bleach (liquid sodium hypochlorite).
- **DON'T** broadcast or sprinkle the chemicals onto the water surface. This method may cause chemically-induced spa surface blistering (chemical abuse).

COMMON WATER CHEMISTRY QUESTIONS

Question: Why can't I use a floater to sanitize my spa water?

Answer: Watkins Manufacturing Corporation does not recommend the use of a floater for three reasons:

1. The floater is unable to control the rate at which the sanitizer is dissolved into the water. When a floater is first placed in a spa, the sanitizer level can be extremely high. High sanitizer levels can chemically burn or discolor the spa's shell or the underside of the cover. Then, after a period of time, the sanitizer level dispensed by the floater will fall to near zero. A low sanitizer level will allow viruses, bacteria, or algae to grow.
2. Floaters tend to stay in one area of the spa most of the time (usually over the cool-down seat), causing this area to be exposed to extreme sanitizer levels.
3. The floater may allow pieces of the highly concentrated sanitizer to fall out and settle on the floor or seat of the spa shell. These pieces of sanitizer will chemically burn (blister) the spa shell. Although your spa shell is specifically designed to resist the effects of spa chemicals, no spa surface can withstand this type of highly concentrated chemical. Remember, chemical abuse is specifically not covered under the terms of the warranty.

Question: When I open my spa, I smell chlorine. How do I get rid of this smell?

Answer: There are two types of chlorine in your spa. The first is the Free Available Chlorine, which is the chlorine available to sanitize your spa. This Free Available Chlorine does not have an odor. The second is Chloramine, which is residue from chlorine already expended. Chloramines have a strong chlorine odor. The smell from Chloramines can be eliminated by "shocking" the water. If you smell chlorine in the water, your spa is reminding you to add a shock treatment.

Question: Why can't I fill my spa with soft water?

Answer: Soft water is essentially the same as regular water except that all of the calcium has been replaced by sodium. Soft water may be corrosive to the heater and other components. Replacement of spa components damaged by soft water is extremely expensive.

Question: I am trying to reduce the number of chemicals to which my family is exposed. Do I really need to use so many chemicals and in such large amounts?

Answer: While over-exposure to any chemical can be unhealthful, many low levels of chemicals are effective and beneficial. In the case of spa water, the chemicals recommended in the Hot Spot® Spa Water Maintenance program are needed to protect the user from water-borne pathogens (disease-causing microbes) and to prevent corrosion of spa components.

Question: Why isn't water chemistry damage covered by the warranty?

Answer: The chemical levels and water quality of the water in the spa are under your direct control. With proper basic care, the spa will provide many years of hot water relaxation. If you are unsure about any chemical or its usage in the spa, contact your Authorized Dealer or Watkins Manufacturing Corporation.

WATER TERMINOLOGY

The following chemical terms are used in this Water Quality and Maintenance section. Understanding their meaning will help you to better understand the water maintenance process.

Bromamines: Compounds formed when bromine combines with nitrogen from body oils, urine, perspiration, etc. Unlike chloramines, bromamines have no pungent odor and are effective sanitizers.

Bromine: A halogen sanitizer (in the same chemical family as chlorine). Bromine is commonly used in stick, tablet, or granular form. See the DOs and DON'Ts of Spa Water Maintenance for additional information.

Calcium Hardness: The amount of dissolved calcium in the spa water. This should be approximately 50-150 ppm. High levels of calcium can cause cloudy water and scaling. Low levels can cause harm to the spa equipment.

Chloramines: Compounds formed when chlorine combines with nitrogen from body oils, urine, perspiration, etc. Chloramines can cause eye irritation as well as having a strong odor. Unlike bromamines, chloramines are weaker, slower sanitizers.

Chlorine: An efficient sanitizing chemical for spas. Watkins Manufacturing Corporation recommends the use of sodium dichlor-type granulated chlorine. This type is preferred because it is totally soluble and nearly pH neutral.

Chlorine (or Bromine) Residual: The amount of chlorine or bromine remaining after chlorine or bromine demand has been satisfied. The residual is, therefore, the amount of sanitizer which is chemically available to kill bacteria, viruses and algae.

Corrosion: The gradual wearing away of metal spa parts, usually caused by chemical action. Generally, corrosion is caused by low pH or by water with levels of TA, CH, pH or sanitizer which are outside the recommended ranges.

DPD: The preferred reagent used in test kits to measure the Free Available Chlorine.

Halogen: Any one of these five elements: fluorine, chlorine, bromine, iodine and astatine.

MPS: Monopersulfate is the non-chlorine oxidizer used with the FreshWater_{Ag+}[®] silver ion purification system.

Oxidizer: The use of an oxidizing chemical is to prevent the buildup of contaminants, maximize sanitizer efficiency, minimize combined chlorine, and improve water clarity.

Pathogen: A microorganism such as bacterium that cause disease.

pH: The measure of the spa water's acidity and alkalinity. The recommended pH for the spa water is 7.4 to 7.6. Below 7.0 (considered neutral), the spa water is too acidic and can damage the heating system. Above 7.8, the water is too alkaline and can result in cloudy water and scale formation on the shell and heater.

ppm: The abbreviation of "parts per million", the standard measurement of chemical concentration in water. Identical to mg/l (milligrams per liter).

Reagent: A chemical material in liquid, powder, or tablet form for use in chemical testing.

Sanitizer: Sanitizers are added and maintained at recommended residuals to protect bathers against pathogenic organisms which can cause disease and infection in spa water.

Scale: Rough calcium-bearing deposits that can coat spa surfaces, heaters, plumbing lines and clog filters. Generally, scaling is caused by mineral content combined with high pH. Additionally, scale forms more readily at higher water temperatures.

Shock Treatment: Also known as "super-chlorination" when chlorine is used. Shock treatment is a process of adding significant doses of a quick dissolving sanitizer (sodium dichlor is recommended) to oxidize non-filterable organic waste and to remove chloramines and bromamines.

Total Alkalinity: The amount of bicarbonates, carbonates, and hydroxides present in spa water. Proper total alkalinity is important for pH control. If the TA is too high, the pH is difficult to adjust. If the TA is too low, the pH will be difficult to hold at the proper level. The desired range of TA in spa water is 40 to 120 ppm.

MAINTENANCE AND SPA CARE

FILTER MAINTENANCE

At least once a week, check and clean the skimmer basket and weir to ensure proper filter flow. Remove leaves, foreign matter, and debris. It is very important to keep your spa filter cartridge clean and free of particles to ensure proper water flow. A clean filter permits the hydrotherapy system to function properly and also allows more efficient filter cycles. Depending on how frequently your spa is used, we recommend cleaning the spa filter cartridge every four weeks. If this is not done, the filter may clog and restrict water flow, which causes improper filtration and poor jet performance.

⚠ **WARNING:** The frequency and duration of use, and the number of occupants all contribute to determining the appropriate time between filter cleanings. More use means that more frequent filter cleanings will be required.

FILTER CARTRIDGE REMOVAL AND CLEANING FOR TEMPO™, RELAY™, STRIDE™, SX & TX SPA MODELS

1. Disconnect the spa from the power supply by turning the power to the spa OFF.
2. Remove any floating items from within the filter compartment.
3. Turn the filter retainer handle (located on the top of the filter cartridge) counterclockwise until the retainer can be removed from the filter standpipe.
4. Remove the filter retainer, *cover and cartridge.

SERVICE NOTE: Never remove the filter standpipe when debris is present in the filter compartment. Debris may find its way into the internal plumbing which may result in blockage. NEVER REMOVE SUCTION FITTINGS!

5. Always clean the filter using a filter degreaser, such as Hot Spring® FreshWater® Filter Cleaner, to remove mineral and oil build-up. Simply soak the filter in the degreaser according to the package directions, then place the filter on a clean surface and spray until clean using a garden hose. It may be necessary to rotate the filter while spraying to remove any debris lodged between the filter pleats.
6. To reinstall the filter cartridge, reverse the order of steps in which it was removed. Do not overtighten.

* Only used on Tempo & Relay Spa Models

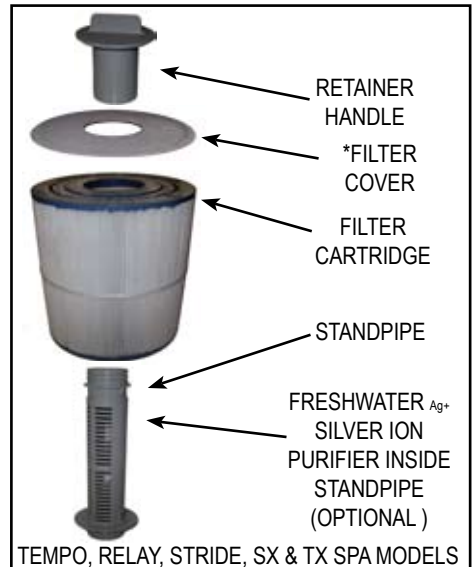

FILTER CARTRIDGE REMOVAL AND CLEANING FOR SPRINT™ & DASH™ SPA MODELS

Turn the spa OFF or turn the power to the spa OFF, then proceed as follows:

1. Remove Filter Cap from Filter Cage by pulling Filter Cap upward.
2. Push the 2 tabs attached to the Filter Cage back into Filter Cage to allow the Basket to be removed (see illustration below).



3. Pull the Basket out of the Filter Cage.
4. Carefully pull up the filter cartridge and bring it out of the spa.
5. Always clean the filter using a filter degreaser, such as Hot Spring FreshWater Filter Cleaner, to remove mineral and oil build-up. Simply soak the filter in the degreaser according to the package directions, then place the filter on a clean surface and spray until clean using a garden hose. It may be necessary to rotate the filter while spraying to remove any debris lodged between the filter pleats.
6. To reinstall the filter cartridge, reverse the order of steps in which it was removed.

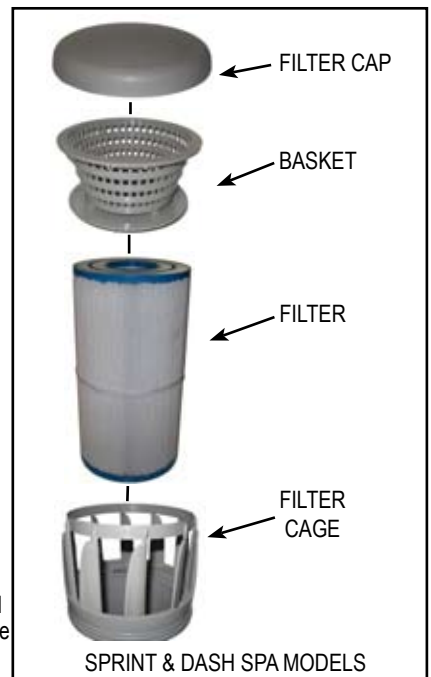

CARE OF THE SPA PILLOWS (TEMPO™, RELAY™, STRIDE™, SX & TX MODELS ONLY)

The spa pillows will provide years of comfort if treated with care. They have been positioned above the water level to minimize the bleaching effects of chlorinated water and other spa water chemicals. To extend their life, whenever the spa shell is being cleaned, the spa pillows should be removed and cleaned. Body oils can be removed with a mild soap and water solution. ALWAYS rinse off the spa pillows thoroughly to remove any soap residue. If the spa is not going to be used for a long period of time (that is during a vacation or if the spa is winterized), or when the spa water is being super-chlorinated, the spa pillows should be removed until the next use of the spa.

To remove and replace the spa pillows:

1. Carefully lift one end of the pillow away from the spa shell.
2. Continue lifting one end until all pillow retainers are released from the pillow.

IMPORTANT: Just pulling the pillow straight up and out of the shell recess will eventually damage the pillow. This abuse is not covered under warranty.

3. To reinstall the spa pillow, carefully bend the pillow slightly to allow one of the pillow retainers to slip into the recess in the back of the pillow.
4. Keeping the pillow slightly bent, slide the other pillow retainer into the recess in the back of the pillow.
5. After all the pillow retainers are in place, press the pillow down into the recess in the spa shell.

CARE OF THE EXTERIOR

SPA SHELL

Stains and dirt generally will not adhere to your spa's surface. A soft rag or a nylon scrubber should easily remove most dirt. Always use a soft, non-abrasive solution (such as baking soda and water mix). Never use cleaners with harsh chemicals or acids, such as citrus, alcohol, or ammonia. Damage to your spa shell can occur. Always thoroughly rinse off any spa shell cleaning agent with fresh water.

SERVICE NOTES:

1. Iron and copper in the water can stain the spa shell if allowed to go unchecked. Always use the Clean Screen™ pre-filter when adding water to the spa to remove copper and iron.
2. The use of alcohol or any household cleaners other than those listed to clean the spa shell surface is NOT recommended. DO NOT use any cleaning products containing abrasives or solvents since they may damage the shell surface. **NEVER USE HARSH CHEMICALS!** Damage to the shell by the use of harsh chemicals is not covered under the warranty.

IMPORTANT: Some surface cleaners contain eye and skin irritants. Keep all cleaners out of the reach of children and use care when applying.

CARE OF THE SPA COVER

⚠ **WARNING:** The cover is a manual safety cover that meets or exceeds all prevailing requirements of ASTM Standards for spa safety covers when installed and used correctly as of the date of manufacture. Non-secured or improperly secured covers are a hazard. Open the cover to its fully open position before use.

VINYL COVER

The vinyl spa cover is an attractive, durable foam insulation product. Monthly cleaning and conditioning are recommended to maintain its beauty.

To clean and condition the vinyl cover:

1. Remove the cover from the spa and gently lean it against a wall or fence.
2. With a garden hose, spray the cover to loosen and rinse away dirt or debris.
3. Using a large sponge and/or a soft bristle brush, and using a very mild soap solution (1 teaspoon dishwashing liquid with 2 gallons (8 liters) of water) or baking soda (sodium bicarbonate), scrub the vinyl top in a circular motion. Do not let the vinyl dry with a soap film on it before it can be rinsed clean.
4. Scrub the cover's perimeter and side flaps. Rinse clean with water.
5. Rinse off the underside of the cover with water only (use no soap), and wipe it clean with a dry rag.

SERVICE NOTE: To remove tree sap, use cigarette lighter fluid (not charcoal lighter fluid). Use sparingly, and rinse with a saddle soap solution immediately afterwards, then wipe dry.

Important reminders:

- **DO** remove snow buildup to avoid breakage of the foam core from the additional weight of the snow.
- **DO** lock cover lock straps to secure the cover when the spa is not in use.
- **DO NOT** drag or lift the spa cover using either the flaps or the cover lock straps.
- **DO NOT** walk, stand, or sit on the cover.

- **DO NOT** place any metal or heat transferring object on the cover or place any type of plastic tarp or drop cloth over the cover as this may result in a melted foam core, which would not be covered under the warranty.
- **DO NOT** use any lifting mechanisms, chemicals or cleaners except those recommended by Watkins Manufacturing Corporation or its Authorized Sales and Service Dealer.

CARE OF THE SPA CABINET

The simulated wood cabinet consists of a rigid polymer that combines the durability of plastic, with the beauty of wood. Simulated wood won't crack, peel, blister, or delaminate even after prolonged exposure to the elements.

Cleaning of simulated wood consists of simply spraying the cabinet with a mild soap and water solution to remove any stains and residue.

DRAINING YOUR SPA

1. **TURN OFF OR DISCONNECT POWER FROM THE SPA.**
2. Remove the equipment compartment access door.
3. Locate the drain cap. Lift drain hose above the water level (requires cutting plastic tie the first time).
4. Unscrew and remove the drain cap.
5. Attach drain hose to garden hose and direct to an appropriate draining area. Maintain hose below water line.
6. After your spa is empty, clean the shell and filter cartridge.
7. After cleaning, remove garden hose and put drain cap back in place.
8. Replace the equipment compartment access door.

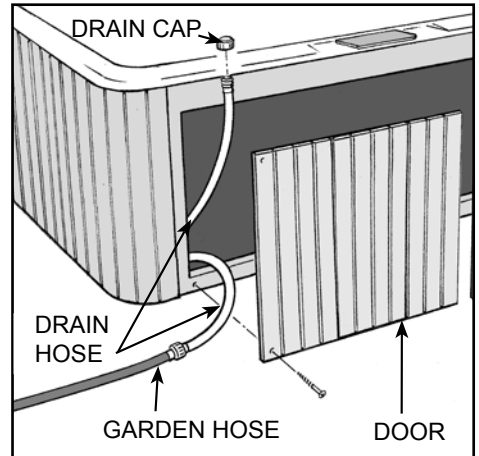

NON-OPERATION IN COLD CLIMATE

If the spa is to be left unused for an extended period of time in areas where FREEZING TEMPERATURES **DO NOT** OCCUR, it may be desirable to turn the heater to the lowest temperature. The automatic filter cycles will keep the spa water clean and sparkling. When preparing the spa for use, check the water chemistry to assure correct chlorine or bromine and pH levels.

You can keep the water in the spa during the time of year when freezing at the spa location may occur. If a freeze condition is detected, the pump and heater will be activated automatically to circulate the water in low speed. However, CAUTION must be used with this approach. In the event of electrical power interruption, regardless of the cause, the heater and pump will stop operating and freeze protection will be lost, possibly resulting in freeze damage to the spa, spa plumbing and/or components. Such damage is not covered by warranty.

PREVENTION OF FREEZING

Your spa has been designed and engineered for year-round use in any climate. In some areas, extremely cold temperatures (below 10°F) combined with strong wind, may cause partial freezing of the jet pump, even though the water inside the spa remains at the selected temperature. The energy efficiency of the spa may also decrease during these cold periods, as the heater will cycle more frequently. As an additional precaution against partial freezing of some of the components, the equipment compartment can be insulated with an insulating kit (available from your local dealer). This insulating kit will also help to maximize the spa's energy efficiency.

NOTE: When warmer weather returns (approx. 60°-70°F, 15.5°-21°C), the insulating kit must be removed to prevent overheating of the jet pump.

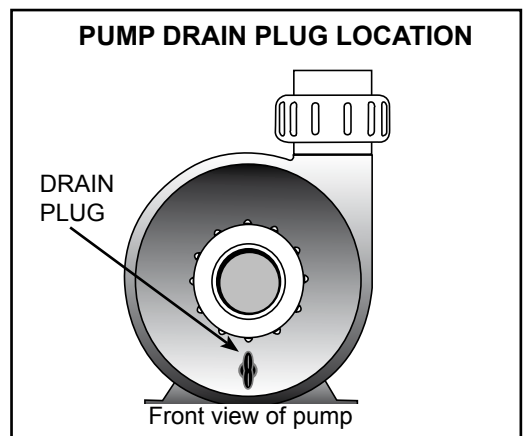

WINTERIZING YOUR SPA

If you leave the spa unused for a long period of time in severely cold weather, you should drain the spa and winterize it to avoid accidental freezing due to a power or equipment failure.

Danger: Use only Propylene Glycol as your anti-freeze (available at most RV or marine supply stores). This is non-toxic. Never use an automobile anti-freeze (Ethylene Glycol) since it is toxic!

Warning: Failure to follow these instructions correctly can lead to freeze damage not covered by warranty. It is strongly recommended that you contact your local dealer to perform this service

1. Drain your spa following the Draining Your Spa section in the owner's manual.
2. Remove the filter cartridge, clean and store in a dry place.
IMPORTANT: These additional instructions must be utilized when draining and winterizing your spa in climates where the temperature falls below 32°F (0°C). A five (5) gallon (19 liters) combination (vacuum/blower) wet/dry shop vac must be used to effectively remove water that is trapped inside the plumbing lines.
3. Attach the vacuum hose to the vacuum side of the shop vac. Vacuum all openings and orifices as follows:
 - a) Jet openings: start with the jets at the top and move downward (if suction is coming from another jet, block off the other jet using a large rag – this will help pull out the water that is trapped deeper inside the main line).
 - b) Filter suction fittings and filter compartment.
 - c) Main drain outlet (it may be necessary to cover the drain grate tightly with a rag when vacuuming the main drain to ensure water is drawn completely from the internal plumbing system).
4. Thoroughly dry the spa shell with a clean towel.
5. Replace the main drain cap.

CAUTION: Use only Propylene Glycol as your anti-freeze. This is non-toxic. Never use an automobile anti-freeze (Ethylene Glycol) since it is toxic!

6. Using a long-extension funnel, pour anti-freeze into all standpipes, filter suction fittings, jet orifices and water feature orifices. Add enough anti-freeze to ensure adequate protection – in many cases, you will see the liquid in the orifice, or coming out of another location.
7. Close the spa cover and fasten the cover tie downs. Cover the spa cover with two pieces of plywood to evenly distribute the weight of snow and ice. Secure a plastic sheet, or tarp, over the spa cover and plywood.
8. Replace the equipment access door, if removed.

OPENING INSTRUCTIONS:

1. Remove plywood and plastic sheet. Open the spa cover by unfastening the cover tie downs.
2. Follow the Start-up and Refill Procedures in the Operating Instructions section of the Owner's Manual. Do not install filters to prevent them from exposure to the anti-freeze.
3. As part of this process, superchlorinate the spa water by adding three teaspoons of chlorine (sodium dichlor) per 250 gallons (950 liters) of spa water into the filter compartment. This is twice the normal amount of chlorine needed for superchlorination. This extra amount of chlorine is needed to destroy the anti-freeze.

NOTE: A defoamer may be needed to decrease the amount of foam caused by the anti-freeze.

4. Drain your spa to ensure removal of anti-freeze. Do not drain water on grass or plants due to excessive chlorine level.
5. After the spa has completely drained, re-install your filter and follow the Start-up and Refill Procedures in the Operating Instructions section of the Owner's Manual.

IMPORTANT: Always keep spa covered when not in use, whether it is empty or full.

SERVICE INFORMATION

GENERAL INFORMATION

Your Hot Spot® spa has been designed to provide years of trouble-free use. As with any appliance, problems may occasionally occur that require the expertise of a qualified service person. Though such simple repairs as resetting a GFCI switch or breaker, high limit thermostat, or pressure switch, or replacing a light bulb may not require a service call, they may indicate that a more serious condition exists. These conditions may require an experienced service person. Before calling for service, please refer to the Troubleshooting Guide.

NOTE: Always retain your original sales receipt for future reference.

GFCI AND HIGH-LIMIT THERMOSTAT

If your spa fails to operate at any time, the following items should be checked:

1. Check the power supply to the spa.
2. Check the GFCI and see if it has tripped. If a GFCI has tripped, reset it. If it will not reset, this may be an indication of a ground fault (short circuit) within the electrical components. Contact an Authorized Service Technician for a complete diagnosis.
3. If, upon checking the GFCI you find it has not tripped, check the house breaker panel and ensure the main breaker for the electrical circuit supplying the spa has not tripped. If it has, this is an indication that either the circuit was overloaded or a ground fault exists between the breaker panel and the spa receptacle. Contact a qualified electrician.
4. If, upon checking the main house breaker, you find no failures, the heater high-limit thermostat should be checked. Tripping of the heater

high-limit thermostat is normally a result of one or a combination of any of these problems: 1)-blockage within the system plumbing, 2) switch malfunction in the heater circuit, or 3) the low speed mode of the jet pump is not functioning.

5. If the heater high-limit has tripped, the control panel display will display - - - (for Tempo™, Relay™, Stride™, SX & TXC Models) or HL (for Sprint™ & Dash™ Models). Reset the heater high-limit by allowing the water to cool and disconnecting power to the spa for at least thirty seconds. If the heater high-limit continues to trip, contact an Authorized Service Technician for a complete diagnosis.

If the spa does not function and the GFCI or GFCI breaker and heater high-limit have not tripped, then the problem should be referred to an Authorized Service Technician. Refer to the Troubleshooting Guide for additional service information.

MISCELLANEOUS SERVICE INFORMATION

The jet pump is equipped with an overload cut-off switch, which is designed to protect the pump from overheating. If the pump shuts itself off in a new spa, it is usually the result of one, or a combination of, the following factors:

High Temperature: During the summer months, especially in warmer climates, the ambient temperature contributes to excessively high temperatures within the equipment compartment.

Improper House Wiring: If the spa is not connected to a dedicated circuit, or is connected to an extension cord, or the house wiring is undersized, the pump may starve for voltage and therefore may draw more amperage and generate excessive heat. This will often cause the circuit breaker to trip repeatedly.

IMPORTANT:

1. If the pump is shutting down due to excessive heat, make sure the equipment compartment has adequate ventilation. The air gap at the bottom and the jet pump vent at the bottom left corner must not be blocked. Should your jet pump continue to shut off after short periods of use, contact a qualified service technician.
2. The Hot Spot® spa is equipped with a safety suction spring valve which will break the prime of the jet pump if both suction fittings are obstructed.

ACTS INVALIDATING WARRANTY

The limited warranty is void if the Hot Spot spa has been subjected to alteration, misuse or abuse, or if any repairs on the spa are attempted by anyone other than an authorized representative of Watkins Manufacturing Corporation. Alteration is defined as any component or plumbing change, electrical conversion, or the addition of any non-approved sanitation, or water purification device, or heating system which contributes to a component failure, unit failure, or unsafe operating condition. Misuse and abuse shall include any operation of the spa other than in accordance with Watkins Manufacturing Corporation printed instructions, or use of the spa in an application for which it is not designed; specifically: use of the spa in a non-residential application; damage caused by operation* of the spa at water temperatures outside the range of 35°F and 120°F (2°C and 49°C); damage caused by a dirty, clogged, or calcified filter cartridge; damage to the spa surface caused by the use of Tri-Chloro Chlorine, BCDMH, chemical tablets in a floater, acid, or any other spa chemicals, or spa surface cleaners which are not recommended by Watkins Manufacturing Corporation; damage caused by allowing undissolved spa sanitizing chemicals to lie on the spa surface (no spa surface material can withstand this kind of abuse); damage to components or spa surface caused by improper water chemistry maintenance; and damage to the spa surface caused by leaving the spa uncovered while empty of water and in direct exposure to sunlight (this may cause solar heating distress in warm weather regions). These are considered abuses and may invalidate this warranty.

*Operation of the spa **DOES NOT** mean “use” of the spa! Watkins Manufacturing Corporation does not recommend using the spa if the water temperature is above or below the spa’s control panel temperature range.

DISCLAIMERS

Watkins Manufacturing Corporation shall not be liable for loss of use of the Hot Spot spa or other incidental or consequential costs, expenses, or damages, which may include but are not limited to, the removal of a permanent deck or other custom fixture. Any implied warranty shall have a duration equal to the duration of the applicable warranty stated above. Under no circumstances shall Watkins Manufacturing Corporation, or any of its representatives, be held liable for injury to any person, or damage to any property, however arising.

WATKINS CUSTOMER SERVICE

If you have any questions about any aspect of your Hot Spot spa set-up, operation, or maintenance that have not been answered by this manual, consult your Hot Spot Spa Dealer.

TROUBLESHOOTING (TEMPO™, RELAY™, STRIDE™, SX & TX)

Watkins Manufacturing Corporation strives to provide the most trouble-free spas on the market. Should you experience any problem whatsoever, do not hesitate to contact your authorized Hot Spot® Spa Dealer. Here are some tips to help you to diagnose and rectify some more common sources of trouble yourself, if you choose to do so.

GENERAL OPERATION TROUBLESHOOTING GUIDE

Problem	Probable causes	Solutions
Entire spa is inoperative	<ul style="list-style-type: none"> Power failure / not plugged in GFCI tripped Heater high-limit thermostat tripped 	<ul style="list-style-type: none"> Check power source Reset GFCI; call for service if it will not reset Disconnect power for at least thirty seconds to reset heater high limit. If it will not reset, check for clogged filters. If tripping continues, call for service.
Spa jets and heat off, light operates (Display reads ==: : : : :)	<ul style="list-style-type: none"> Pressure switch is open and should be closed. 	<ul style="list-style-type: none"> Check for clogged filter. The pressure switch will reset when the flow of water through the heater has been restored. Call for service if the pressure switch trips frequently
(Display reads =====)	<ul style="list-style-type: none"> Pressure switch senses flow through heater even though jet pump is off. 	Power failure / not plugged in
READY icon flashes	<ul style="list-style-type: none"> Control Sensor open or shorted 	<ul style="list-style-type: none"> Contact an Authorized Service Technician
Jets weak or surging	<ul style="list-style-type: none"> Spa water level too low Filters clogged / Jet intake screens clogged Jet nozzles closed / Air valve closed 	<ul style="list-style-type: none"> Add water Clean filters / Clean jet intake screens Open jet nozzles / Open air valve
Light inoperative	<ul style="list-style-type: none"> Spa lock activated Light wiring or assembly is faulty 	<ul style="list-style-type: none"> Deactivate spa lock Replace light assembly.
Display reads - - - - (Entire spa inoperative)	<ul style="list-style-type: none"> Heater high-limit thermostat tripped 	<ul style="list-style-type: none"> Disconnect power to the spa for at least thirty seconds to reset the heater high-limit. If tripping continues, clean the filter, then if tripping still occurs, call for service..
Set water temperature significantly different from display temperature	<ul style="list-style-type: none"> System Controls 	<ul style="list-style-type: none"> Contact an Authorized Service Technician

SPA WATER MAINTENANCE TROUBLESHOOTING GUIDE

Problem	Probable causes	Solutions
Cloudy Water	<ul style="list-style-type: none"> Dirty filters Excessive oils / organic matter Improper sanitization Suspended particles / organic matter Overused or old water 	<ul style="list-style-type: none"> Clean filters Shock spa with sanitizer Add sanitizer Adjust pH and/or alkalinity to recommended range Run jet pump(s) and clean filters Drain and refill the spa
Water Odor	<ul style="list-style-type: none"> Excessive organics in water Improper sanitization Low pH 	<ul style="list-style-type: none"> Shock spa with sanitizer Add sanitizer Adjust pH to recommended range
Chlorine Odor	<ul style="list-style-type: none"> Chloramine level too high Low pH 	<ul style="list-style-type: none"> Shock spa with sanitizer Adjust pH to recommended range
Musty Odor	<ul style="list-style-type: none"> Bacteria or algae growth 	<ul style="list-style-type: none"> Shock spa with sanitizer—if problem is visible or persistent, drain, clean and refill the spa
Organic buildup / scum ring around spa	<ul style="list-style-type: none"> Build-up of oils and dirt 	<ul style="list-style-type: none"> Wipe off scum with clean rag – if severe, drain the spa, use a spa surface and tile cleaner to remove the scum, and refill the spa
Algae Growth	<ul style="list-style-type: none"> High pH Low sanitizer level 	<ul style="list-style-type: none"> Shock spa with sanitizer and adjust pH Shock spa with sanitizer and maintain sanitizer level
Eye Irritation	<ul style="list-style-type: none"> Low pH Low sanitizer level 	<ul style="list-style-type: none"> Adjust pH Shock spa with sanitizer and maintain sanitizer level
Skin Irritation / Rash	<ul style="list-style-type: none"> Unsanitary water Free chlorine level above 5 ppm 	<ul style="list-style-type: none"> Shock spa with sanitizer and maintain sanitizer level Allow free chlorine level to drop below 5 ppm before spa use
Stains	<ul style="list-style-type: none"> Total alkalinity and/or pH too low High iron or copper in source water 	<ul style="list-style-type: none"> Adjust total alkalinity and/or pH Use a metal deposit inhibitor
Scale	<ul style="list-style-type: none"> High calcium content in water – total alkalinity and pH too high 	<ul style="list-style-type: none"> Adjust total alkalinity and pH – if scale requires removal, drain the spa, scrub off the scale, refill the spa and balance the water

TROUBLESHOOTING (SPRINT™ & DASH™ MODELS)

Watkins Manufacturing Corporation strives to provide the most trouble-free spas on the market. Should you experience any problem whatsoever, do not hesitate to contact your authorized Hot Spot® Spa Dealer. Here are some tips to help you to diagnose and rectify some more common sources of trouble yourself, if you choose to do so.

GENERAL OPERATION TROUBLESHOOTING GUIDE

Problem	Probable causes	Solutions
Entire spa is inoperative	<ul style="list-style-type: none"> Power failure / not plugged in GFCI tripped Heater high-limit thermostat tripped 	<ul style="list-style-type: none"> Check power source Reset GFCI; call for service if it will not reset Disconnect power for at least thirty seconds to reset heater high limit. If it will not reset, check for clogged filters. If tripping continues, call for service.
Spa jets and heat off, light operates Display reads FLO	<ul style="list-style-type: none"> Pressure switch is open and should be closed. 	<ul style="list-style-type: none"> Check for clogged filter. The pressure switch will reset when the flow of water through the heater has been restored. Call for service if the pressure switch trips frequently
Display reads FLC	<ul style="list-style-type: none"> Pressure switch senses flow through heater even though jet pump is off. 	Contact an Authorized Service Technician
Jets weak or surging	<ul style="list-style-type: none"> Spa water level too low Filters clogged / Jet intake screens clogged Jet nozzles closed / Air valve closed 	<ul style="list-style-type: none"> Add water Clean filters / Clean jet intake screens Open jet nozzles / Open air valve
Light inoperative	<ul style="list-style-type: none"> Light wiring or assembly is faulty 	<ul style="list-style-type: none"> Replace light assembly.
Display reads HL (Entire spa inoperative)	<ul style="list-style-type: none"> Heater high-limit thermostat tripped 	<ul style="list-style-type: none"> Disconnect power to the spa for at least thirty seconds to reset the heater high-limit. If tripping continues, clean the filter, then if tripping still occurs, call for service..
Set water temperature significantly different from display temperature	<ul style="list-style-type: none"> System Controls 	<ul style="list-style-type: none"> Contact an Authorized Service Technician

SPA WATER MAINTENANCE TROUBLESHOOTING GUIDE

Problem	Probable causes	Solutions
Cloudy Water	<ul style="list-style-type: none"> Dirty filters Excessive oils / organic matter Improper sanitization Suspended particles / organic matter Overused or old water 	<ul style="list-style-type: none"> Clean filters Shock spa with sanitizer Add sanitizer Adjust pH and/or alkalinity to recommended range Run jet pump(s) and clean filters Drain and refill the spa
Water Odor	<ul style="list-style-type: none"> Excessive organics in water Improper sanitization Low pH 	<ul style="list-style-type: none"> Shock spa with sanitizer Add sanitizer Adjust pH to recommended range
Chlorine Odor	<ul style="list-style-type: none"> Chloramine level too high Low pH 	<ul style="list-style-type: none"> Shock spa with sanitizer Adjust pH to recommended range
Musty Odor	<ul style="list-style-type: none"> Bacteria or algae growth 	<ul style="list-style-type: none"> Shock spa with sanitizer—if problem is visible or persistent, drain, clean and refill the spa
Organic buildup / scum ring around spa	<ul style="list-style-type: none"> Build-up of oils and dirt 	<ul style="list-style-type: none"> Wipe off scum with clean rag – if severe, drain the spa, use a spa surface and tile cleaner to remove the scum, and refill the spa
Algae Growth	<ul style="list-style-type: none"> High pH Low sanitizer level 	<ul style="list-style-type: none"> Shock spa with sanitizer and adjust pH Shock spa with sanitizer and maintain sanitizer level
Eye Irritation	<ul style="list-style-type: none"> Low pH Low sanitizer level 	<ul style="list-style-type: none"> Adjust pH Shock spa with sanitizer and maintain sanitizer level
Skin Irritation / Rash	<ul style="list-style-type: none"> Unsanitary water Free chlorine level above 5 ppm 	<ul style="list-style-type: none"> Shock spa with sanitizer and maintain sanitizer level Allow free chlorine level to drop below 5 ppm before spa use
Stains	<ul style="list-style-type: none"> Total alkalinity and/or pH too low High iron or copper in source water 	<ul style="list-style-type: none"> Adjust total alkalinity and/or pH Use a metal deposit inhibitor
Scale	<ul style="list-style-type: none"> High calcium content in water – total alkalinity and pH too high 	<ul style="list-style-type: none"> Adjust total alkalinity and pH – if scale requires removal, drain the spa, scrub off the scale, refill the spa and balance the water

PRIMING THE PUMP(S)

Upon filling or refilling the spa, if a pump is operating and water is not flowing from any of its jets, the pump may not be properly primed. To correct, refer to the illustration below and perform the following procedures:

- Turn off power to the spa at the breaker and remove the equipment compartment door.
- **Loosen** the union on the top of the pump(s) to allow the air to escape. When water is present, hand-tighten the union.
- Turn power back on, activate the pump and check to make sure union is tight enough to keep it from leaking. Re-install equipment door.

NOTE: Equipment compartment illustrated below will vary depending on spa model.

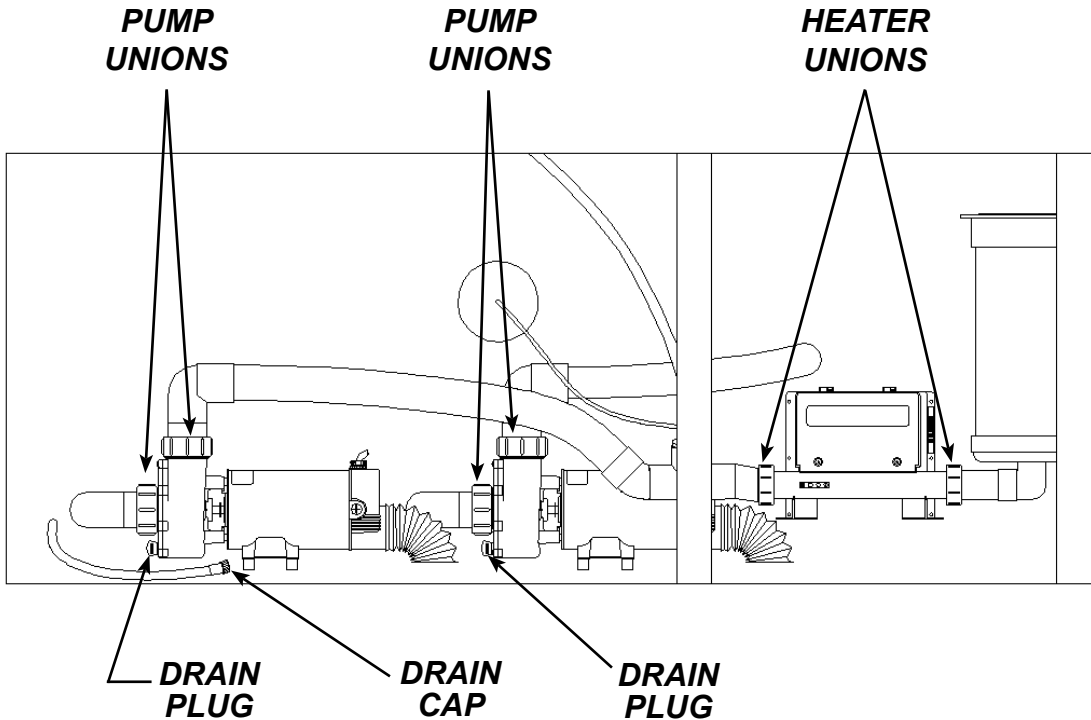

IMPORTANT

THE DRAIN CAP AND UNION FITTINGS IN THE EQUIPMENT COMPARTMENT MAY LOOSEN DURING TRANSPORTATION. TO AVOID LEAKS, PLEASE CHECK TO MAKE SURE THESE ARE HAND-TIGHT PRIOR TO FILLING YOUR SPA.

Watkins

The Home Relaxation Specialists

This manual contains installation, operating, maintenance and service information for the following 2010 Hot Spot® Spa models:

TEMPO™ (MODEL TEME)
RELAY™ (MODEL RELE)
STRIDE™ (MODEL STDE)
SX (MODEL SXE)
TX (MODEL TXE)
SPRINT™ (MODEL SPRE)
DASH™ (MODEL DASE)

HOT SPOT

The logo graphic consists of three stylized, overlapping wavy lines in a teal color, resembling water or a hot tub's shape, positioned below the 'HOT SPOT' text.

©2010 Watkins Manufacturing Corporation. Hot Spot, Tempo, Relay, Sprint, Dash, Precision, No-Fault, FreshWater, FreshWater_{Ag+}, EverFresh, Clean Screen and Vanishing Act are trademarks of Watkins Manufacturing Corporation. BaquaSpa is a trademark of Arch UK Biocides Limited. Brominating Concentrate™ is a trademark of Bio-Lab Inc.



Watkins Manufacturing Corporation
Vista, California USA

www.hotspothottubs.com

PART #302183, REV. A (10/10)